

fusion scope™

by Quantum Design

FusionScope is an easy-to-use correlative microscopy platform designed from the ground up to add the benefits of SEM imaging to a wide range of AFM measurement techniques.

Featuring an innovative shared coordinate system to automatically align AFM and SEM operations for measurements and sample positioning, within a single software interface you now can easily identify your area of interest, measure your sample, and combine your imaging data in real time.

ONE platform... multiple applications

Acquire detailed **Material Characterization** of your samples, including structural, mechanical, electrical, and magnetic properties. Carry out high-level **Quality Control** of manufactured parts or perform **Failure Analysis** on electrical components or semiconductor devices.

Easily characterize **Nanostructures** such as nanowires, 2D-materials, and nanoparticles. FusionScope gives you full control to locate your area of interest, position your probe, and perform a wide range of measurements.

*Correlated MFM & SEM
data from duplex steel*

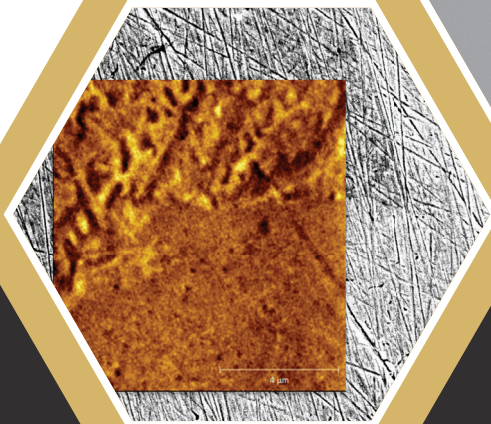

*AFM tip measuring
razor blade edge*

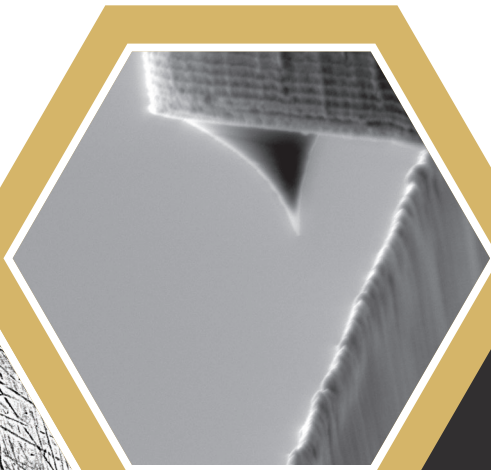

*By combining the complementary strengths of
AFM and SEM, FusionScope opens the door
to a world of new application possibilities.*



TRUE correlative microscopy

Interactively overlay AFM imaging data onto SEM images while operating the microscope in real time. Create stunning 2D and 3D visualizations with nanoscale resolution.

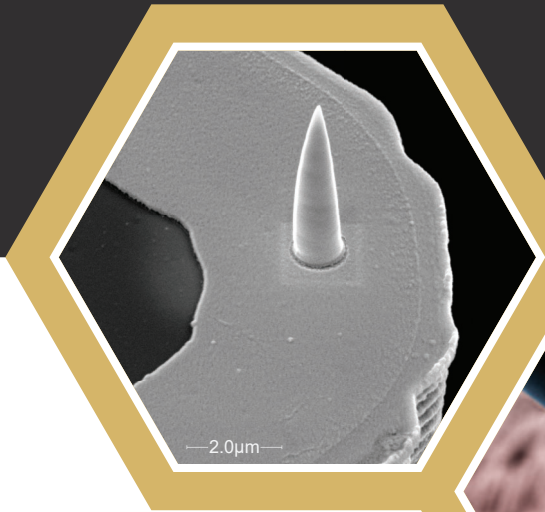
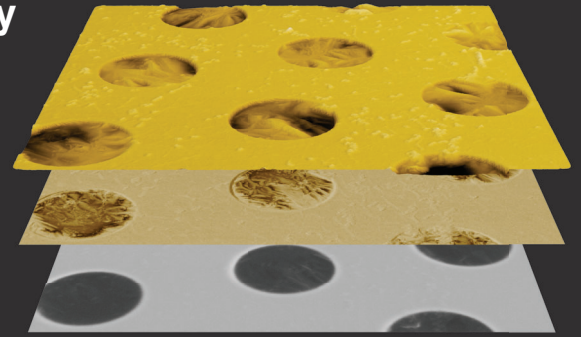

Conductive C-AFM tip

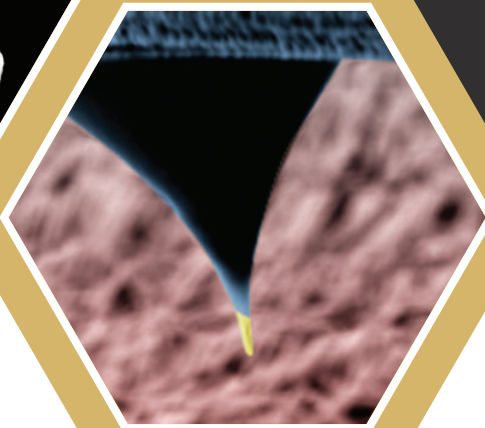

Magnetic MFM tip

POWERFUL, yet easy to use ...the best of both worlds

Switch between a sub-nanometer resolution AFM and SEM imaging with a simple click of a button to extract your desired data. FusionScope is capable of most standard AFM measurement modes, including contact, dynamic, and FIRE modes.

Finite Impulse REsponse (FIRE) mode is a novel off-resonance intermittent contact scanning force microscopy technique. Comparison of the excitation profile to the cantilever deflection allows the measurement of sample stiffness and tip adhesion in real time.

Interchangeable cantilevers easily provide advanced measurement modes within the same software interface, such as Conductive AFM (C-AFM) and Magnetic Force Microscopy (MFM).

AFM topography image measured with FIRE mode of two component polymer sample (polystyrene and polyolefin elastomer)

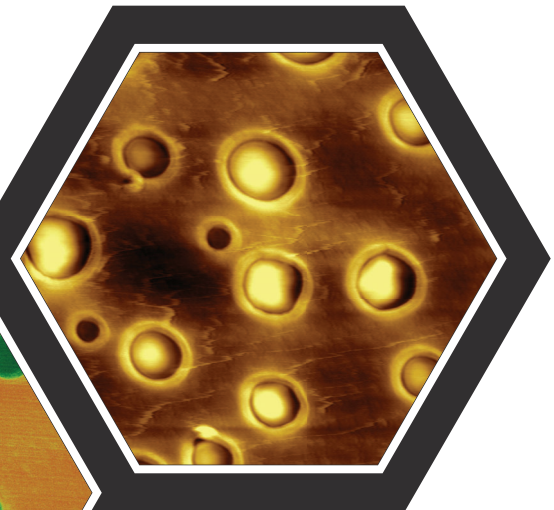

Corresponding stiffness measured with FIRE mode of two component polymer sample (polystyrene and polyolefin elastomer)

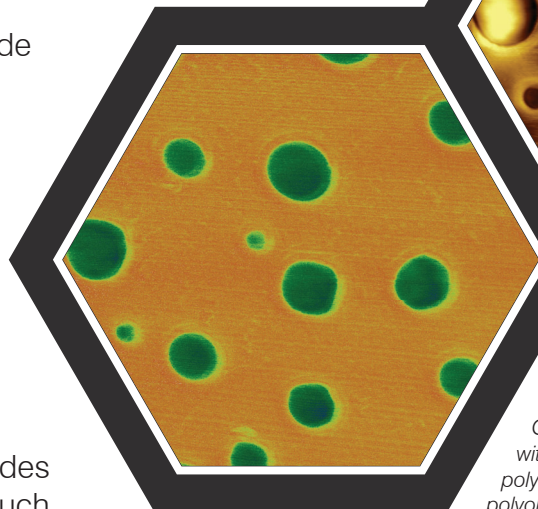

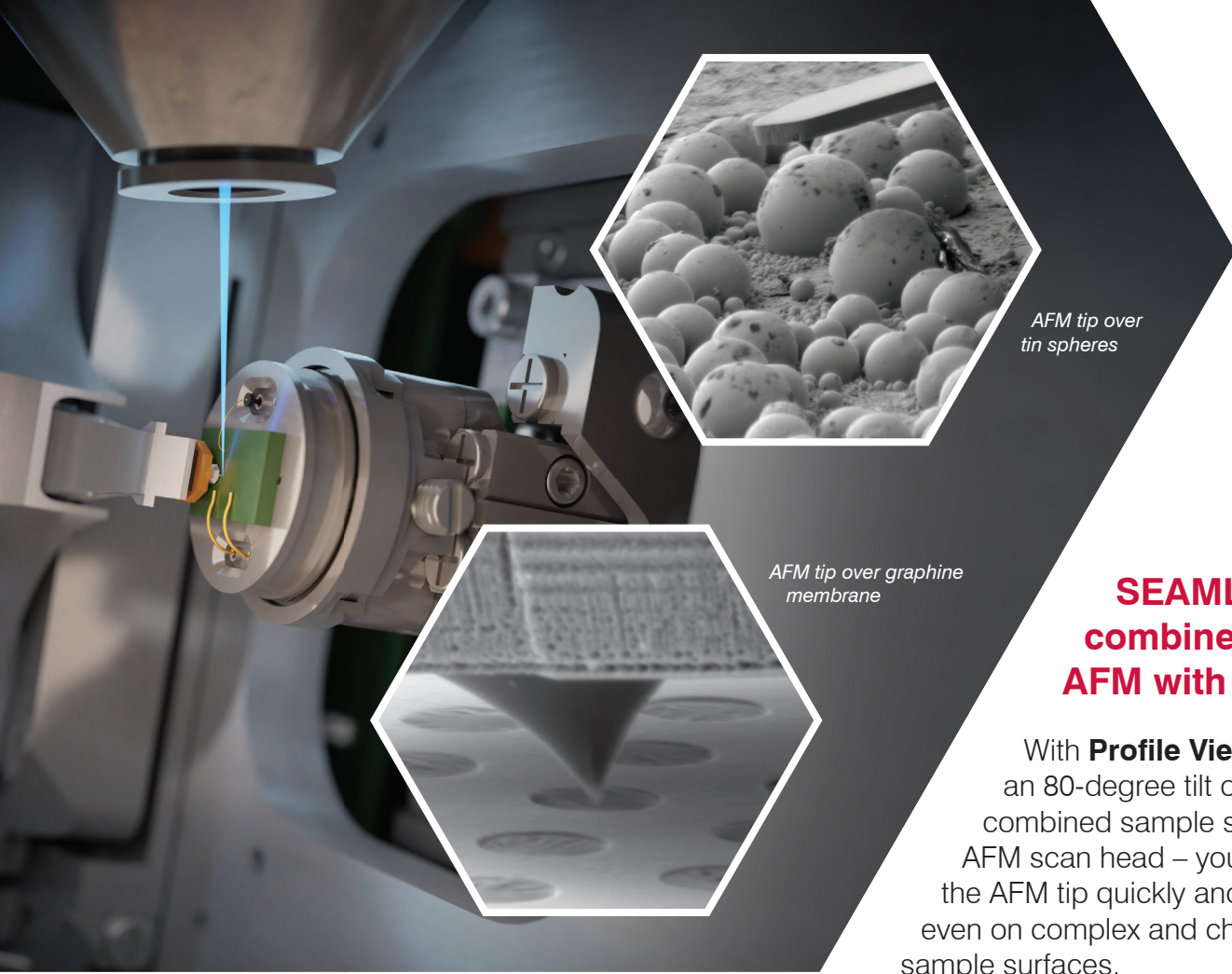

AFM tip over tin spheres

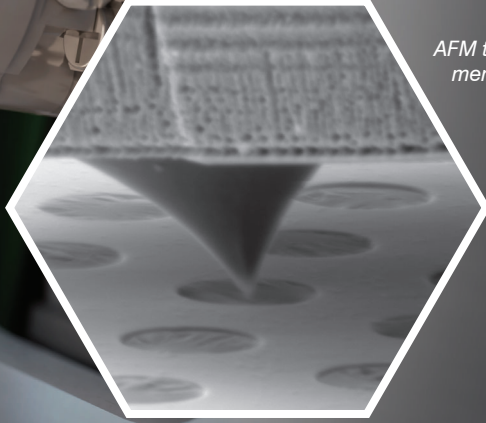

AFM tip over graphine membrane

SEAMLESSLY combine AFM with SEM

With **Profile View** – an 80-degree tilt of the combined sample stage and AFM scan head – you can position the AFM tip quickly and precisely, even on complex and challenging sample surfaces.

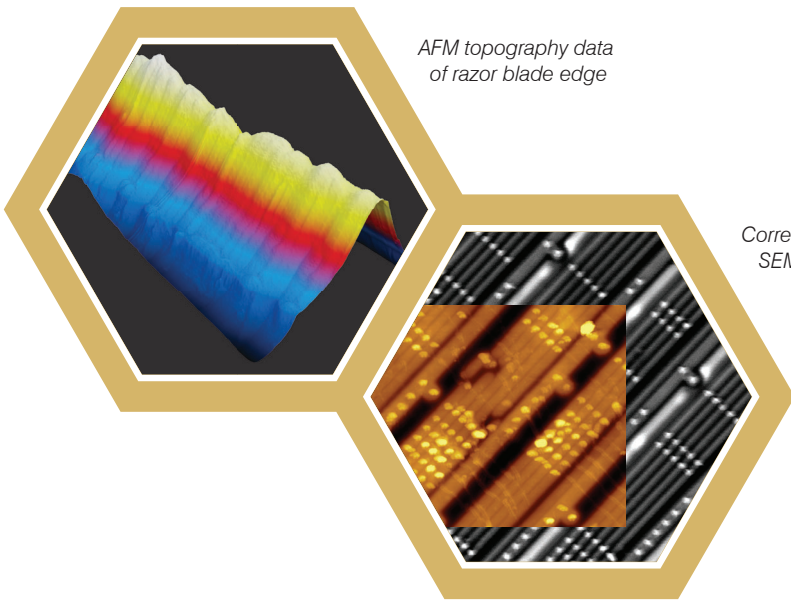

AFM topography data of razor blade edge

Correlated AFM and SEM data of CPU chip

EASY-TO-USE correlative microscopy

Focus on your research and let FusionScope do the rest. **FusionScope's software** provides automation for most routine functions within an intuitive and customizable user interface. Intelligent data handling organizes all your AFM and SEM data for easy access in the future.

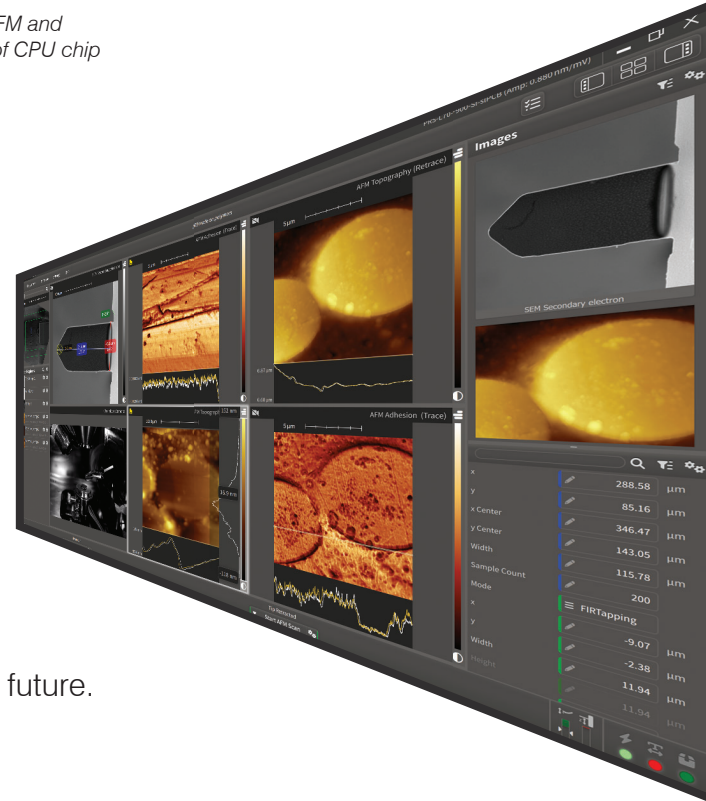

x	288.58	μm
y	85.16	μm
x Center	346.47	μm
y Center	-2.38	μm
Width	143.05	μm
Sample Count	115.78	μm
Mode	200	
x	-9.07	μm
y	11.94	μm
Width	11.94	μm
Height	11.94	μm

Specifications*

AFM	Scan Range XY:	22 x 22 μm (Closed Loop)
	Scan Range Z:	15 μm
	Imaging Noise:	< 50 pm @ 1 kHz
	Cantilever Probes:	Self-Sensing Piezoresistive
	Measurement Modes:	Contact, Dynamic, FIRE, MFM, C-AFM, ...
SEM	Electron Source:	Thermal Field Emission
	Acceleration Voltage:	3.5 kV – 15 kV
	Probe Current:	5 pA – 2.5 nA (300 pA typical)
	Magnification:	25 X – 200,000 X
	Detectors:	In-Chamber SE (Everhart-Thornley)
Sample	Max. Sample Diameter:	20 mm (12 mm Full Correlated Mode)
	Max. Sample Height:	20 mm
	Max. Sample Weight:	500 g
	Eucentric Alignment::	Automatic
Chamber	Typical Chamber Vacuum:	1-10 μTorr
	Pumping Time:	< 5 min
	Trunnion Tilt:	-10 to 80 Degrees
System	Power:	200-230 VAC; 50/60 Hz; Single Phase 15 A
	Dimensions (W x L x H):	690 x 835 x 1470 mm
	Weight:	330 kg

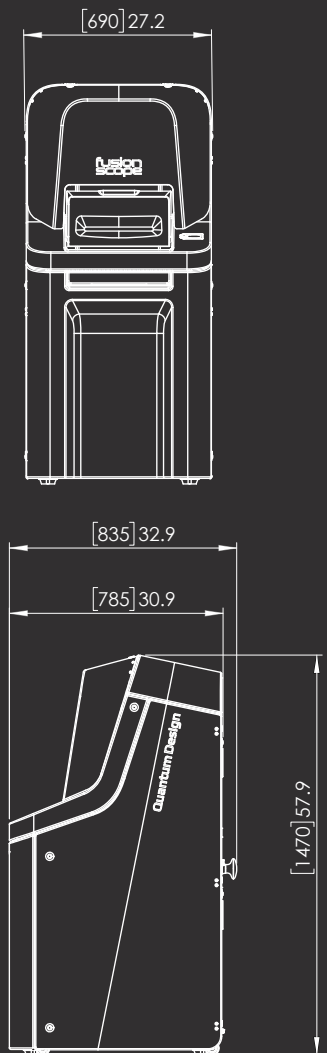

* Specifications subject to change without notice 1081-300 Rev. B0



Quantum Design, Inc.
 10307 Pacific Center Court, San Diego, CA 92121
 Tel: 858-481-4400 Fax: 858-481-7410
www.fusionscope.com info@fusionscope.com

