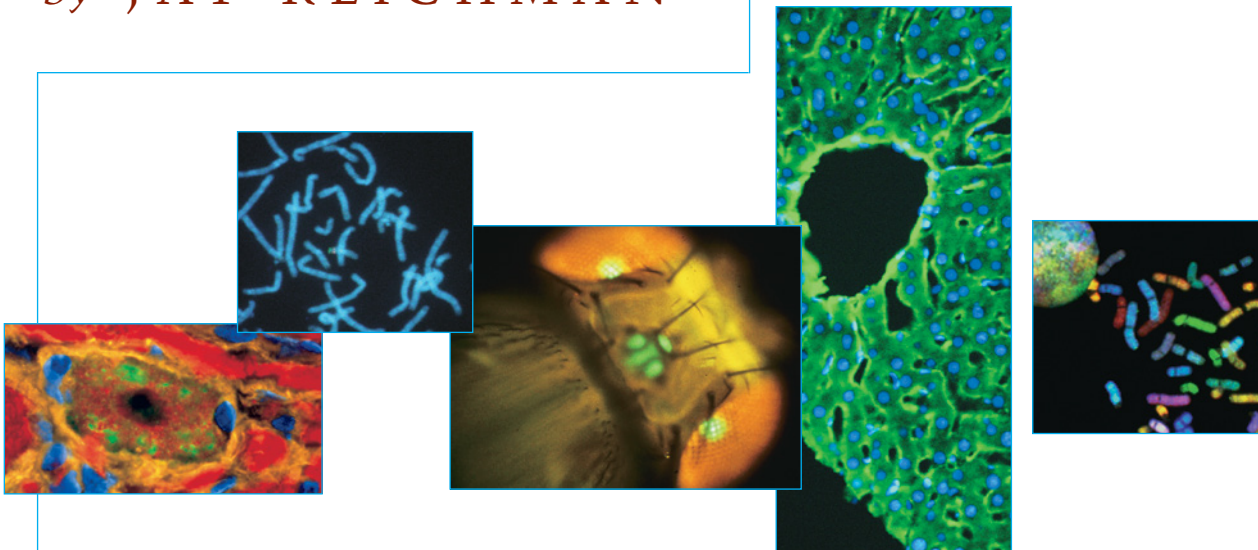


C H R O M A   T E C H N O L O G Y   C O R P

HANDBOOK *of*  
OPTICAL FILTERS  
*for* FLUORESCENCE  
MICROSCOPY

*by* JAY REICHMAN



# C H R O M A T E C H N O L O G Y C O R P

## HANDBOOK *of* OPTICAL FILTERS *for* FLUORESCENCE MICROSCOPY

by JAY REICHMAN

### AN INTRODUCTION TO FLUORESCENCE MICROSCOPY **2**

---

Excitation and emission spectra  
Brightness of the fluorescence signal  
The fluorescence microscope  
Types of filters used in fluorescence microscopy  
The evolution of the fluorescence microscope

### A GENERAL DISCUSSION OF OPTICAL FILTERS **8**

---

Terminology  
Available products  
    Colored filter glass  
    Thin-film coatings  
    Acousto-optical filters  
    Liquid Crystal Tunable Filters

### DESIGNING FILTERS FOR FLUORESCENCE MICROSCOPY **14**

---

Image Contrast  
    Fluorescence spectra  
    Light sources  
    Detectors  
    Beamsplitters  
Optical quality  
    Optical quality parameters  
    Optical quality requirements for wide-field microscopy

### FILTER SETS FOR SUB-PIXEL REGISTRATION **24**

---

### FILTERS FOR CONFOCAL MICROSCOPY **25**

---

Optical quality requirements  
    Nipkow-disk scanning  
    Laser scanning  
Spectral requirements  
    Nipkow-disk scanning  
    Laser scanning

### FILTERS FOR MULTIPLE PROBE APPLICATIONS **29**

---

### REFERENCES **30**

---

### GLOSSARY **31**

---

---

Fluorescence microscopy requires optical filters that have demanding spectral and physical characteristics. These performance requirements can vary greatly depending on the specific type of microscope and the specific application. Although they are relatively minor components of a complete microscope system, optimally designed filters can produce quite dramatic benefits, so it is useful to have a working knowledge of the principles of optical filtering as applied to fluorescence microscopy.

This guide is a compilation of the principles and know-how that the engineers at Chroma Technology Corp use to design filters for a variety of fluorescence microscopes and applications, including wide-field microscopes, confocal microscopes, and applications involving simultaneous detection of multiple fluorescent probes. Also included is information on the terms used to describe and specify optical filters and practical information on how filters can affect the optical alignment of a microscope.

Finally, the handbook ends with a glossary of terms that are italicized or in boldface in the text.

For more in-depth information about the physics and chemistry of fluorescence, applications for specific fluorescent probes, sample-preparation techniques, and microscope optics, please refer to the various texts devoted to these subjects. One useful and readily available resource is the literature on fluorescence microscopy and microscope alignment published by the microscope manufacturers.

---

## ABOUT CHROMA TECHNOLOGY CORP

---

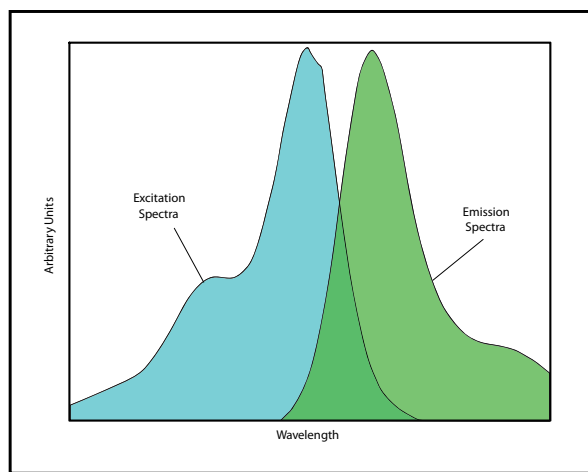
Employee-owned Chroma Technology Corp specializes in the design and manufacture of optical filters and coatings for applications that require extreme precision in color separation, optical quality, and signal purity:

- low-light-level fluorescence microscopy and cytometry
- spectrographic imaging in optical astronomy
- laser-based instrumentation
- Raman spectroscopy.

Our coating lab and optics shop are integrated into a single facility operated by a staff with decades of experience in both coating design and optical fabrication. We are dedicated to providing the optimum cost-effective solution to your filtering requirements. In most cases our staff will offer, at no extra charge, expert technical assistance in the design of your optical system and selection of suitable filtering components.

# AN INTRODUCTION TO FLUORESCENCE MICROSCOPY

Fluorescence is a molecular phenomenon in which a substance absorbs light of some color and almost instantaneously<sup>1</sup> radiates light of another color, one of lower energy and thus longer wavelength. This process is known as **excitation** and **emission**. Many substances, both organic and non-organic, exhibit some fluorescence. In the early days of fluorescence microscopy (at the turn of the century) microscopists looked at this **primary fluorescence**, or **autofluorescence**, but now many dyes have been developed that have very bright fluorescence and are used to selectively stain parts of a specimen. This method is called **secondary** or **indirect fluorescence**. These dyes are called **fluorochromes**, and when conjugated to other organically active substances, such as antibodies and nucleic acids, they are called **fluorescent probes** or **fluorophores**. (These various terms are often used interchangeably.) There are now fluorochromes that have characteristic peak emissions in the near-infrared as well as the blue, green, orange, and red colors of the spectrum. When indirect fluorescence via fluorochromes is used, the autofluorescence of a sample is generally considered undesirable: it is often the major source of unwanted light in a microscope image.



**FIGURE 1**  
Generic excitation and emission spectra  
for a fluorescent dye.

## EXCITATION AND EMISSION SPECTRA

**Figure 1** shows a typical spectrum of the excitation and emission of a fluorochrome. These spectra are generated by an instrument called a *spectrofluorimeter*, which is comprised of two spectrometers: an illuminating spectrometer and an analyzing spectrometer. First the dye sample is strongly illuminated by a color of light that is found to cause some fluorescence. A spectrum of the fluorescent emission is obtained by scanning with the analyzing spectrometer using this fixed illumination color. The analyzer is then fixed at the brightest emission color, and a spectrum of the excitation is obtained by scanning with the illuminating spectrometer and measuring the variation in emission intensity at this fixed wavelength. For the purpose of designing filters, these spectra are normalized to a scale of relative intensity.

These color spectra are described quantitatively by wavelength of light. The most common wavelength unit for describing fluorescence spectra is the *nanometer (nm)*. The colors of the visible spectrum can be broken up into the approximate wavelength values (**Figure 2**):

violet and indigo	400 to 450 nm
blue and aqua	450 to 500 nm
green	500 to 570 nm
yellow and orange	570 to 610 nm
red	610 to approximately 750 nm

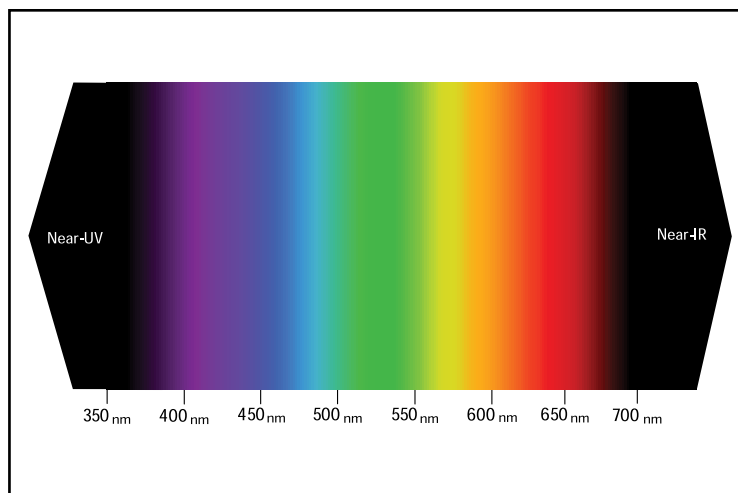
<sup>1</sup> The time it takes for a molecule to fluoresce is on the order of nanoseconds ( $10^{-9}$  seconds). Phosphorescence is another photoluminescence phenomenon, with a lifetime on the order of milliseconds to minutes.

On the short-wavelength end of the visible spectrum is the near-ultraviolet (near-UV) band from 320 to 400 nm, and on the long-wavelength end is the near-infrared (*near-IR*) band from 750 to approximately 2500 nm. The broad band of light from 320 to 2500 nm marks the limits of transparency of crown glass and window glass, and this is the band most often used in fluorescence microscopy. Some applications, especially in organic chemistry, utilize excitation light in the mid-ultraviolet band (190 to 320 nm), but special UV-transparent illumination optics must be used.

There are several general characteristics of fluorescence spectra that pertain to fluorescence microscopy and filter design. First, although some substances have very broad spectra of excitation and emission, most fluorochromes have well-defined bands of excitation and emission. The spectra of **Figure 1** are a typical example. The difference in wavelength between the peaks of these bands is referred to as the *Stokes shift*. Second, although the overall intensity of emission varies with excitation wavelength, the spectral distribution of emitted light is largely independent of the excitation wavelength.<sup>2</sup> Third, the excitation and emission of a fluorochrome can shift with changes in cellular environment such as pH level, dye concentration, and conjugation to other substances. Several dyes (FURA-2 and Indo-1, for example) are useful expressly because they have large shifts in their excitation or emission spectra with changes in concentration of ions such as  $H^+$  (pH level),  $Ca^{2+}$ , and  $Na^+$ . Lastly, there are photochemical reactions that cause the fluorescence efficiency of a dye to decrease with time, an effect called *photobleaching* or *fading*.

## BRIGHTNESS OF THE FLUORESCENCE SIGNAL

Several factors influence the amount of fluorescence emitted by a stained specimen with a given amount of excitation intensity. These include 1) the dye concentration within stained sections of the specimen, and the thickness of the specimen; 2) the *extinction coefficient* of the dye; 3) the *quantum efficiency* of the dye; and, of course, 4) the amount of stained material actually present within the field of view of the microscope. The extinction coefficient tells us how much of the incident light will be absorbed by a given dye concentration and specimen thickness, and reflects the wavelength-dependent absorption characteristics indicated by the excitation spectrum of the fluorochrome. Although many of the fluorochromes have high extinction coefficients at peak excitation wavelengths, practical sample preparation techniques often limit the maximum concentration allowed in the sample, thus reducing the overall amount of light actually absorbed by the stained specimen.



**FIGURE 2**  
Color regions of the spectrum.

<sup>2</sup>The emission spectrum might change "shape" to some extent, but this is an insignificant effect for most applications. See Lakowicz (1983) for an in-depth description of the mechanism of fluorescence.

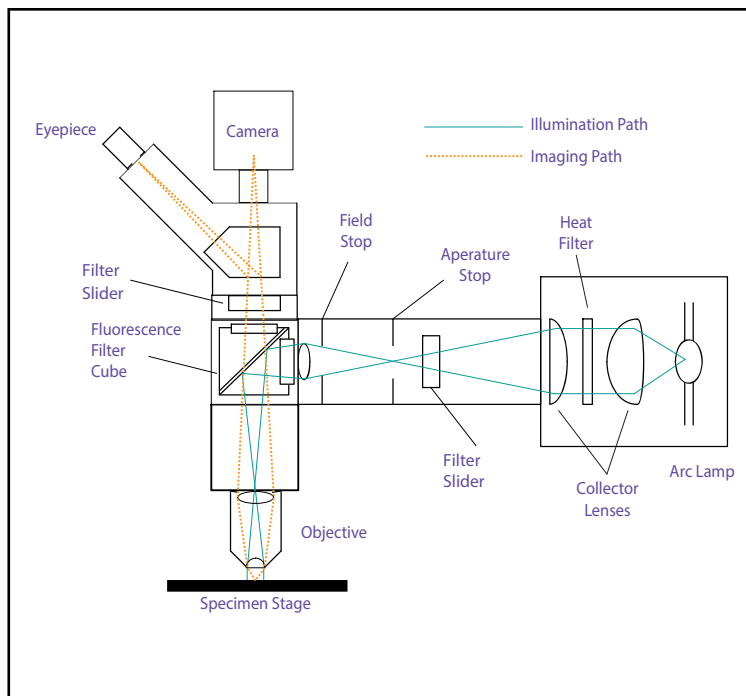
The quantum efficiency, which is the ratio of light energy absorbed to fluorescence emitted, determines how much of this absorbed light energy will be converted to fluorescence. The most efficient common fluorochromes have a quantum efficiency of approximately 0.3, but the actual value can be reduced by processes known as *quenching*, one of which is photobleaching.

The combination of these factors, in addition to the fact that many specimens have very small amounts of stained material in the observed field of view, gives a ratio of emitted fluorescence intensity to excitation light intensity in a typical application of between  $10^{-4}$  (for very highly fluorescent samples) and  $10^{-6}$ . Current techniques (e.g. fluorescence *in situ* hybridization), which utilize minute amounts of fluorescent material, might have ratios as low as  $10^{-9}$  or  $10^{-10}$ .

Thus, in order to see the fluorescent image with adequate contrast, the fluorescence microscope must be able to attenuate the excitation light by as much as  $10^{-11}$  (for very weak fluorescence) without diminishing the fluorescence signal. How does the fluorescence microscope correct for this imbalance? Optical filters are indeed essential components, but the inherent configuration of the fluorescence microscope also contributes greatly to the filtering process.

## THE FLUORESCENCE MICROSCOPE

**Figure 3** is a schematic diagram of a typical *epifluorescence* microscope, which uses incident-light (i.e., *episcopic*) illumination. This is the most common type of fluorescence microscope. Its most important feature is that by illuminating with incident light it need only filter out excitation light scattering back from the specimen or reflecting from glass surfaces. The use of high-quality oil-immersion objectives (made with materials that have minimal autofluorescence and using low-fluorescence oil) eliminates surface reflections, which can reduce the level of back-scattered light to as little as 1/100 of the incident light. In addition, the dichroic beamsplitter, which reflects the excitation light into the objective, filters out the back-scattered excitation light by another factor of 10 to 500. (The design of these beamsplitters is described below.)



**FIGURE 3**  
Schematic of a wide-field epifluorescence microscope, showing the separate optical paths for illuminating the specimen and imaging the specimen:  
illumination path ————  
imaging path ······

An epifluorescence microscope using oil immersion, but without any filters other than a good dichroic beamsplitter, can reduce the amount of observable excitation light relative to observed fluorescence to levels ranging from 1 (for very bright fluorescence) to  $10^5$  or  $10^6$  (for very weak fluorescence). If one wants to achieve a *background* of, say, one-tenth of the fluorescence image, then additional filters in the system are needed to reduce the observed excitation light by as much as  $10^{-6}$  or  $10^{-7}$  (for weakly fluorescing specimens) and still transmit almost all of the available fluorescence signal. Fortunately, there are filter technologies available (described in the section beginning on page 10) that are able to meet these stringent requirements.

## TYPES OF FILTERS USED IN FLUORESCENCE MICROSCOPY

The primary filtering element in the epifluorescence microscope is the set of three filters housed in the fluorescence *filter cube* (also called the *filter block*): the *excitation filter*, the *emission filter*, and the *dichroic beamsplitter*. A typical filter cube is illustrated schematically in **Figure 4**.

1) The **excitation** filter (also called the *exciter*) transmits only those wavelengths of the illumination light that efficiently excite a specific dye. Common filter blocks are named after the type of excitation filter:

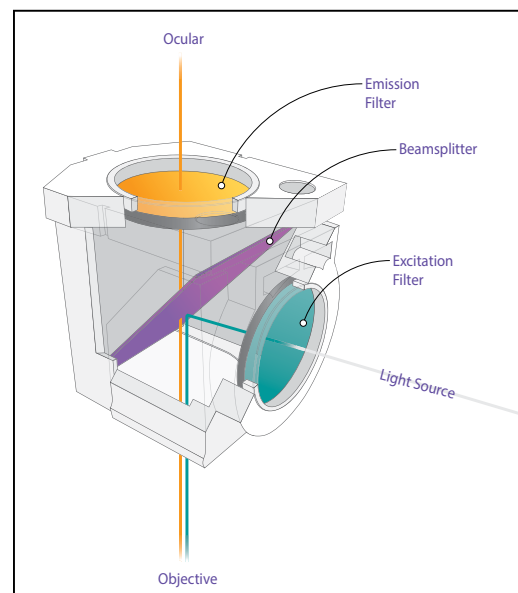
UV or U	Ultraviolet excitation for dyes such as DAPI and Hoechst 33342
B	Blue excitation for FITC and related dyes
G	Green excitation for TRITC, Texas Red <sup>®</sup> , etc.

Although shortpass filter designs were used in the past, bandpass filter designs are now used almost exclusively.

2) The **emission** filter (also called the *barrier filter* or *emitter*) attenuates all of the light transmitted by the excitation filter and very efficiently transmits any fluorescence emitted by the specimen. This light is always of longer wavelength (more to the red) than the excitation color. These can be either bandpass filters or longpass filters. Common barrier filter colors are blue or pale yellow in the U-block, green or deep yellow in the B-block, and orange or red in the G-block.

3) The **dichroic beamsplitter** (also called the *dichroic mirror* or *dichromatic beamsplitter*<sup>3</sup>) is a thin piece of coated glass set at a 45-degree angle to the optical path of the microscope. This coating has the unique ability to reflect one color, the excitation light, but transmit another color, the emitted fluorescence. Current dichroic beamsplitters achieve this with great efficiency, i.e., with greater than 95% reflectivity of the excitation along with approximately 95% transmission of the emission. This is a great improvement over the traditional gray half-silvered mirror, which reflects only 50% and transmits only 50%, giving only about 25% efficiency. The glass (called the *substrate*) is usually composed of a material with low autofluorescence such as UV-grade fused silica.

Most microscopes have a slider or turret that can hold from two to four individual filter cubes. **It must be noted that the filters in each cube are a matched set, and one should avoid mixing filters and beamsplitters unless the complete spectral characteristics of each filter component are known.**



**FIGURE 4**  
Schematic of a fluorescence filter cube

<sup>3</sup>The term "dichroic" is also used to describe a type of crystal or other material that selectively absorbs light depending on the polarization state of the light. (Polaroid<sup>®</sup> plastic film polarizer is the most common example.) To avoid confusion, the term "dichromatic" is sometimes used.

Other optical filters can also be found in fluorescence microscopes:

1) A *heat filter*, also called a *hot mirror*, is incorporated into the illuminator collector optics of most, but not all, microscopes. It attenuates infrared light (typically wavelengths longer than 800 nm) but transmits most of the visible light.

2) *Neutral-density filters*, usually housed in a filter slider or filter wheel between the collector and the aperture diaphragm, are used to control the intensity of illumination.

3) Filters used for techniques other than fluorescence, such as color filters for transmitted-light microscopy and linear polarizing filters for polarized light microscopy, are sometimes installed.

## THE EVOLUTION OF THE FLUORESCENCE MICROSCOPE<sup>4</sup>

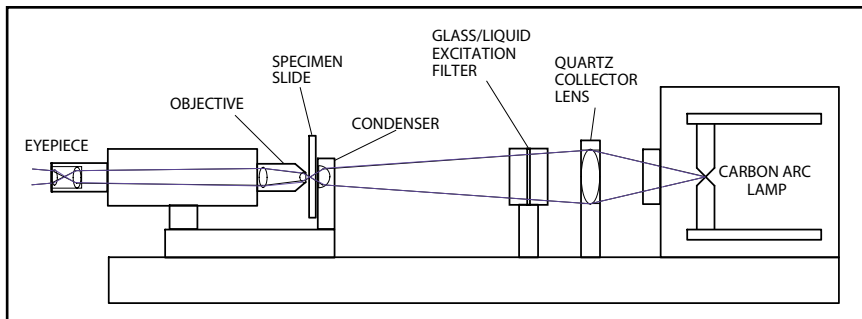
The basic configuration of the modern fluorescence microscope described above is the result of almost 100 years of development and innovation. By looking at its development over the years, one can gain a better understanding of the function of these various components.

The first fluorescence microscopes achieved adequate separation of excitation and emission by exciting the specimen with invisible ultraviolet light. This minimized the need for barrier filters.<sup>5</sup> One of these turn-of-the-century microscopes used for its light source a bulky and hazardous 2000 W iron arc lamp filtered by a combination of Wood's solution (nitrosodimethylaniline dye) in gelatin, a chamber of liquid copper sulfate, and blue-violet colored filter glass. This first excitation filter produced a wide band of near-UV light with relatively little visible light, enabling the microscopist to observe the inherent primary fluorescence of specimens. Microscopists were aided by the fact that most substances will fluoresce readily when excited by UV light. In

1914 fluorochromes were first used with this type of microscope to selectively stain different parts of cells, the first utilization of secondary fluorescence.<sup>6</sup>

These first fluorescence microscopes, illustrated schematically in **Figure 5**, used *diascopic* (i.e., transmitted light) illumination. Both *brightfield* and *darkfield* oil-immersion condensers were

used, but each had certain important disadvantages. With the brightfield condenser, the maximum intensity of illumination was severely limited by the capabilities of the optical filters that were available at the time. The



**FIGURE 5**  
Schematic of an early transmitted-light fluorescence microscope.  
(After Kasten, 1989.)

<sup>4</sup> Most of this information is taken from the following excellent reference: Kasten (1989).

<sup>5</sup> The first barrier filter to be used was a pale yellow coverslip, which protected the eye from hazardous radiation, but some of the early fluorescence microscopes might have lacked even this.

<sup>6</sup> Several fluorescent dyes were synthesized in the eighteenth century for other purposes, including use as chemotherapeutic drugs that stained parasitic organisms and sensitized them to damaging rays.



---

darkfield condenser, which directed the excitation light into a cone of light at oblique angles, prevented most of the excitation light from entering the objective lens, thus reducing the demands on the optical filters. However, the efficiency of the illumination was greatly reduced, and the objective lens required a smaller *numerical aperture*, which resulted in a further reduction in brightness as well as lower resolution.<sup>7</sup>

The most important advance in fluorescence microscopy was the development of episcopic illumination for fluorescence microscopes in 1929. *Episcopic illumination* was first utilized to observe the fluorescence of bulk and opaque specimens. These first epifluorescence microscopes probably used half-silvered mirrors for the beamsplitter, with a maximum overall efficiency of 25%, but important advantages were 1) the ability to use the high numerical aperture objective as the condenser, thus achieving greater brightness; 2) the fact that the intensity of excitation light that reflects back into an oilimmersion objective is, as discussed above, roughly 1% of the incident light;<sup>8</sup> and 3) ease of alignment. The development of dichroic mirrors, introduced by E. M. Brumberg in 1948 for ultraviolet excitation and independently developed by J. S. Ploem in the 1960's to enable visible excitation, increased the efficiency of beamsplitters to nearly 100% and further improved the filtering capabilities of the microscope. Further advances in the optics of epi-illuminators by Ploem included the introduction of narrow-band interference filters for blue and green excitation and the development of the filter-cube, which permitted an easy exchange of filters and beamsplitters for multiple fluorochromes.<sup>9</sup> These advances led to the commercialization of the epifluorescence microscope.

Other important technical advances during this historical period were 1) the development of compact mercury-vapor and xenon arc lamps (1935); 2) advances in the manufacture of colored filter glasses, which enabled the use of fluorochromes that were efficiently excited by visible light (thus allowing, for example, the use of simple tungsten filament light sources); 3) advances in microscope objective design; and 4) the introduction of anti-reflection coatings for microscope optics (c. 1940).

More recent technological developments have enabled fluorescence microscopy to keep pace with the remarkable advances in the biological and biomedical sciences over the years. These include ultrasensitive cameras<sup>10</sup>, laser illumination, confocal and multi-photon microscopy, digital image processing, new fluorochromes and fluorescent probes, and, of course, great improvements in optical filters and beamsplitters.

<sup>7</sup> Abramowitz (1993).

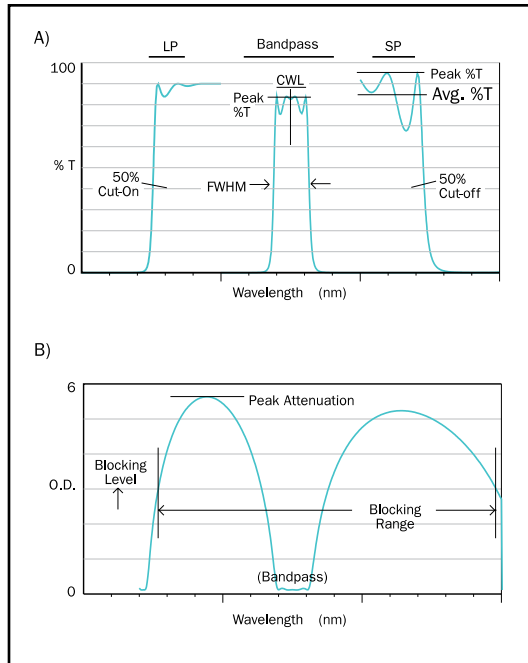
<sup>8</sup> Assuming nonmetallic specimens.

<sup>9</sup> Information and sequence of events confirmed through communication with Dr. Bas Ploem, 2006.

<sup>10</sup> Inoué (1986) is an excellent text detailing the use of video imaging and microscopes in general.

# A GENERAL DISCUSSION OF OPTICAL FILTERS

Before describing in detail the design of optical filters for fluorescent microscopy, it is worthwhile to introduce some of the terms used to specify filter performance and describe the characteristics of available products.



**FIGURE 6**  
**A) Nomenclature for transmission characteristics**  
**B) Nomenclature for blocking**

## TERMINOLOGY

Although color designations such as U, B, and G are often adequate for describing the basic filter sets, it is useful to be familiar with the terms used for more precise descriptions of filters, especially when dealing with special sets for unusual dyes and probes. The most common unit for describing filter performance is the wavelength of light in nanometers, the same as for fluorochrome spectra described previously. Note that the perceived color of a filter depends on the bandwidth (described below) as well as specific wavelength designation. This is especially noticeable when looking through filters in the range of 550 to 590 nm: a filter with a narrow band will look pale green while a filter with a wide band, especially a longpass filter, will look yellowish or even bright orange.

Some of the important terms used to describe the spectral performance of optical filters are defined below. Please refer to the illustrations in **Figures 6 through 9**.

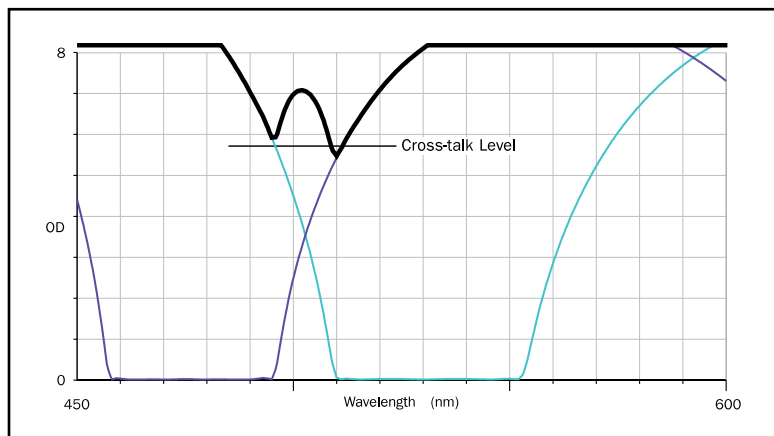
1) **Bandpass filters** are denoted by their *center wavelength (CWL)* and *bandwidth (FWHM)*.<sup>11</sup> The center wavelength is the arithmetic mean of the wavelengths at 50% of peak transmission. The FWHM is the bandwidth at 50% of peak transmission.

2) **Longpass and shortpass cut-on filters (LP and SP)** are denoted by their cut-on or cut-off wavelengths at 50% of peak transmission. LP or SP filters that have a very sharp slope (see next page) are often called *edge filters*. The *average transmission* is calculated over the useful transmission region of the filter, rather than over the entire spectrum. (Please note that the use of terms “highpass” and “lowpass” are discouraged because they more accurately describe frequency rather than wavelength.)

3) The **attenuation level**, also called *blocking level*, and **attenuation range**, also called *blocking range*, are normally defined in units of *optical density (OD)*:

$$OD = -\log(T) \text{ or } OD = -\log(\%T / 100)$$

$$\text{Example: } OD 4.5 = 3 \times 10^{-5} T (0.003 \%T)$$



**FIGURE 7**  
**Cross-talk level of two filters in series.**

Optical density uses the same logarithmic units as the quantity *absorbance*, which is a measure of absorption, but filters can attenuate light in various

<sup>11</sup> Full Width at Half of Maximum Transmission

ways other than absorption. For example, thin-film interference filters block primarily by reflection, and acousto-optical filters block by diffraction. Therefore, the term “optical density” is more precise. (Both of these filter products are described in detail in the section beginning on page 10.)

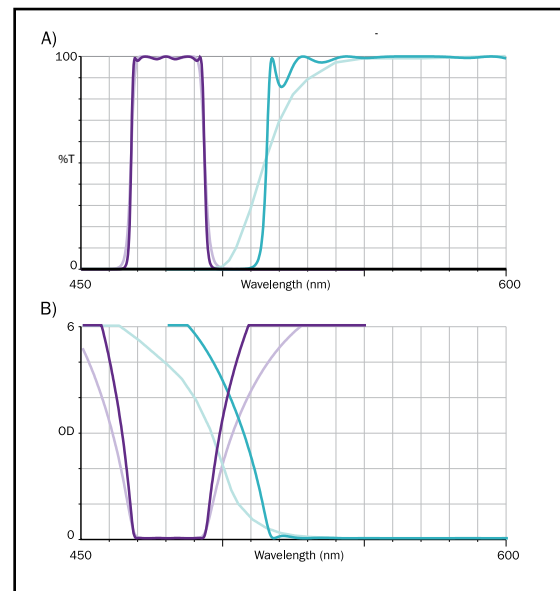
A term related to attenuation level is **cross-talk** (Figure 7), which describes the minimum attenuation level (over a specific range) of two filters placed together in series. This value is important when matching excitation filters with emission filters for a fluorescence filter set.

4) The term **slope** describes the sharpness of the transition from transmission to blocking. Figure 8 illustrates two sets of filters with the same bandwidth or cut-on point but different slope. In the Figure note that although the bandpass filters look very similar on a 100% transmission scale, the slopes as indicated on the optical density scale are significantly different. Slope can be specified by stating the wavelength at which a particular filter must have a specified blocking level.

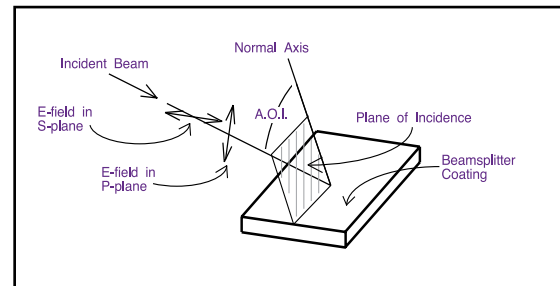
5) The **angle of incidence** (AOI) is the angle between the optical axis of the incident light and the axis normal to the surface of the filter, as illustrated in Figure 9. Most filters are designed to be used at zero degrees angle of incidence, called *normal* incidence, but for beamsplitter coatings the usual angle is 45 degrees. It should be noted that most types of filters, such as thin-film interference coatings and acousto-optical crystal devices, are “angle-sensitive,” which means that the characteristic performance changes with angle. (These products are described in greater detail in the next section.) If a filter or beamsplitter is to be used at any angle other than the usual zero- or 45-degree angle, it must be specified explicitly.

One consequence of angle sensitivity is that the **half-cone angle** of the incident light might need to be specified if the filter is to be used in a converging or diverging beam (Figure 10). The half-cone angle can also be described in terms of the f-number, or the *numerical aperture (NA)*, of the light beam, which equals the sine of the half-cone angle.

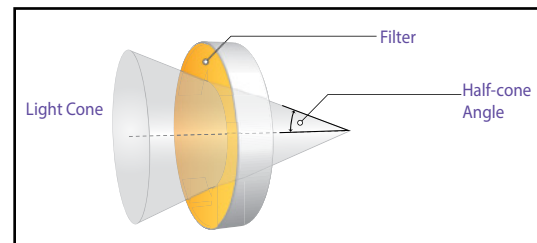
6) Dichroic beamsplitters (and, in fact, any thin-film interference coating that is used at non-normal angles-of-incidence) will cause some amount of **polarization** (see Glossary), the precise effect varying greatly with wavelength and with the particular coating design. Some relevant terms are illustrated in Figure 9: P-plane (also called TM-mode, i.e., *transverse magnetic*) is the component of the electric field vibration that is parallel to the plane of incidence of the beamsplitter, and S-plane (also TE-mode, i.e., *transverse electric*) is the component of the electric field vibration that is perpendicular to the plane of incidence of the beamsplitter. The polarizing effect of a typical dichroic beamsplitter is illustrated in Figure 11.



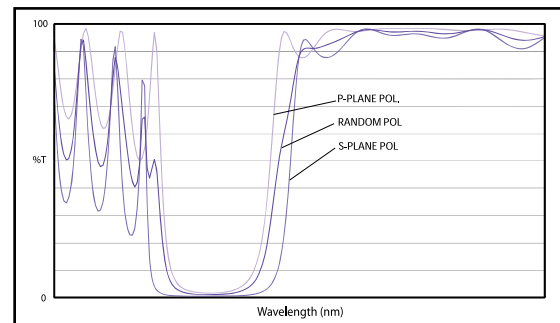
**FIGURE 8**  
Filter sets with varying slope, shown in A) percent transmission and B) in optical density.



**FIGURE 9**  
Schematic illustration of terms used to describe polarization. The normal axis is the axis perpendicular to the surface of the coating, and the plane of incidence is defined by the normal axis and the direction vector of the incident light beam.



**FIGURE 10**  
Illustration of half-cone angle of divergent or convergent incident light.



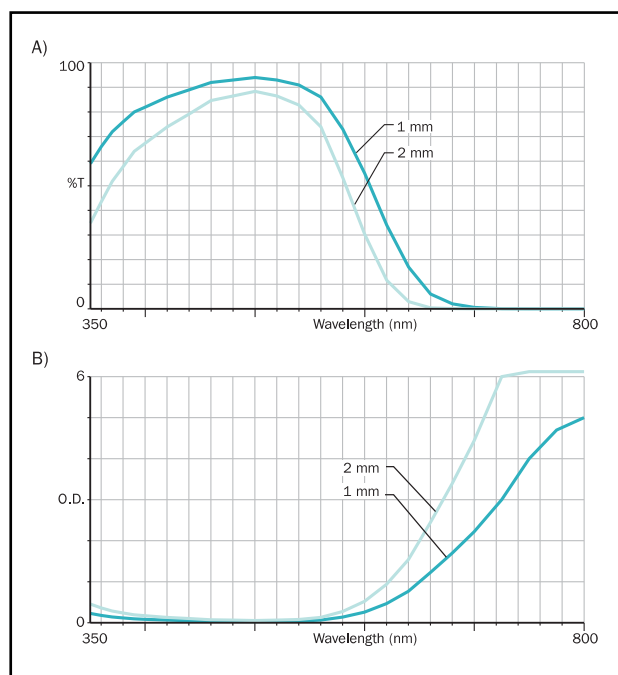
**FIGURE 11**  
Polarizing effect of a typical dichroic mirror. This particular coating is designed for reflecting the 488 nm linearly polarized argon-ion laser line in the S-plane.

## AVAILABLE PRODUCTS

The two main types of filter technology used in fluorescence analysis are colored filter glass and thin-film coatings. In addition, acousto-optical tunable filters are finding increased use in special applications. These products are described below. Other products, such as holographic filters and liquid-crystal tunable filters, are available, but they are used infrequently in fluorescence microscopy.

### Colored Filter Glass

Colored filter glass, also called *absorption glass*, is the most widely used type of filter in fluorescence analysis, particularly the yellow and orange sharpcut glasses and “black” glasses that transmit the UV and absorb the visible. Filter glass attenuates light solely by absorption, so the spectral performance is dependent on the physical thickness of the glass. Increasing the thickness will increase the blocking level but also reduce the peak in-band transmission (**Figure 12**), so an optimum thickness value must be determined. Stock thicknesses offered by the glass manufacturers represent a thickness value that is typical for the general uses of the glass, but other thicknesses might be better for a specific application.



**FIGURE 12**  
Spectra of near-IR blocking glass (Schott® BG-39) at 1 mm and 2 mm thickness, shown in A) percent internal transmission and B) optical density.  
(From Schott Glasswerke catalogue.)

#### Following are some advantages of filter glass:

- 1) It is relatively inexpensive;
- 2) It is stable and long-lived under normal conditions;<sup>12</sup>
- 3) Its spectral characteristics are independent of angle of incidence, except for slight changes due to increased effective thickness.

#### Disadvantages of filter glass include the following:

- 1) There is a limited selection of glasses;
- 2) The bandpass types have poor slope and often low peak transmittance;
- 3) There is less flexibility in the specification of filter thickness because of the dependence of spectral performance on thickness;
- 4) Most of the longpass filter glasses have high auto-fluorescence;
- 5) Since absorption converts most of the radiant energy into heat, untempered filter glass might crack under conditions of intense illumination.

Included in the category of filter glass are polymer-based filters, which are sometimes used as longpass barrier filters because they have low autofluorescence compared to an equivalent filter glass, and a type of neutral-density glass (not to be confused with thin-film neutral-density coatings described below).

<sup>12</sup> Some minor exceptions are: 1) sharp-cut longpass filter glasses have a shift in cut-on of approximately 0.1 to 0.15 nm/ °C temperature change; and 2) some types of filter glass can be affected by unusual environments such as intense UV radiation (“solarization”) or high humidity. (Schott Glasswerke catalogue.)

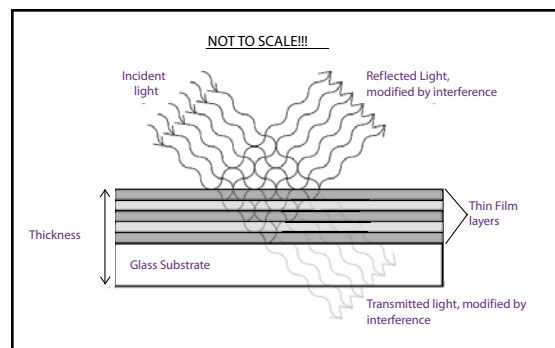
## Thin-Film Coatings

Two widely used categories of thin-film coating are 1) metallic coatings for making fully reflective mirrors and neutral-density filters; and 2) *thin-film interference coatings*, which are the main component of interference filters. The main advantage of thin-film interference coatings is the tremendous flexibility of performance inherent in the way they work. As shown in **Figure 13**, interference coatings are composed of a stack of microscopically thin layers of material, each with a thickness on the order of a wavelength of light (usually around a quarter of a wavelength of light—approximately 1/10,000 of a millimeter in thickness). Although each material is intrinsically colorless, the reflections created at each interface between the layers combine through wave interference to selectively reflect some wavelengths of light and transmit others. A common natural example of thin-film interference is the formation of swirls of color on a soap bubble. Interference occurs between the reflections from the inner and outer surfaces of the bubble, and the colors follow contours of constant thickness within the single layer of soap.<sup>13</sup>

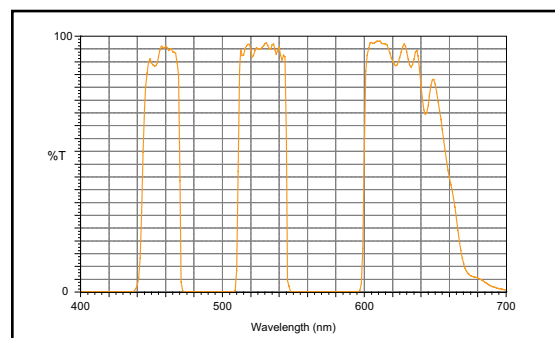
Almost any filter type can be designed using interference coatings, including bandpass, shortpass, and longpass filters, and dichroic beamsplitters. By adjusting the number of layers in the stack and the thickness of each layer, one can control to high precision the nominal wavelength, the bandwidth, and the blocking level. One can also create filters with greater complexity than the standard bandpass, longpass, or shortpass. For example, filters with multiple bands produced using the modified magnetron sputter deposition process, illustrated in **Figure 14**, have several highly transmissive bands and are valuable tools in fluorescence microscopy.

There are several limitations to thin-film interference coatings, including the following:

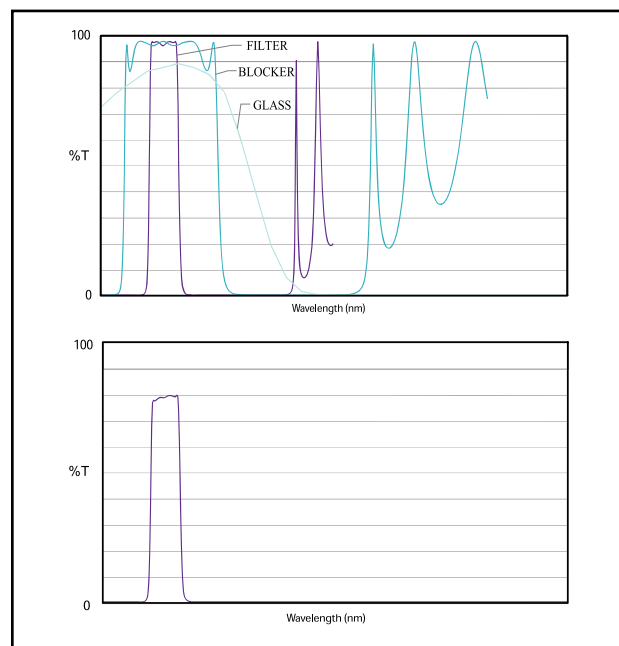
1) In traditional interference filter design, the characteristic blocking performance only holds within a finite wavelength range. This coating technology has been the industry standard for many decades, using dielectric materials in a sealed, laminated format. Additional components, both interference coatings and absorption glass, can be added to increase blocking range, but with reduced transmission and increased physical thickness. An example of a filter with no added blocking (often called an "unblocked" filter), and the same filter blocked with added components, is shown in **Figure 15**. For applications such as fixed cell stains, plant imaging with autofluorescence, flow cytometry, plate readers, and anywhere there is an adequate signal this type of filter performs excellently.



**FIGURE 13**  
Schematic illustration of a thin-film interference coating

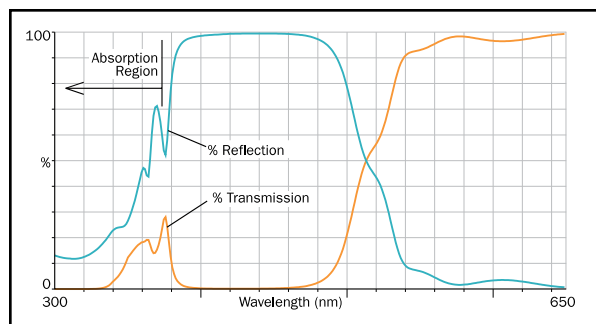


**FIGURE 14**  
Spectra of a triple-band filter designed for DAPI, FITC, and Texas Red® emissions. (Chroma Technology Corp P/N 69002 emission filter)



**FIGURE 15**  
An example of a blocked filter: A) spectra of an unblocked filter and blocking components, including a wide-band “blocker” and infrared-blocking blue filter glass; and B) the spectrum of the blocked filter. The blocking range in the infrared (not shown) is determined by the range of the blue glass, approximately 1.2 microns.

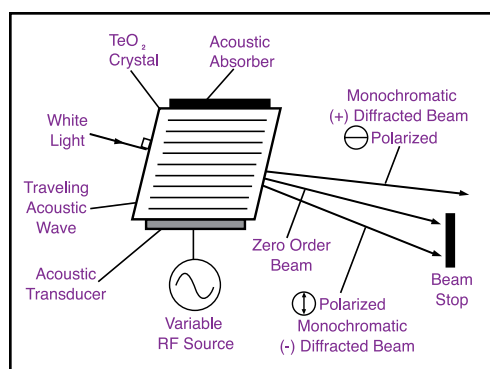
<sup>13</sup> But unlike a soap bubble, the optical thin-films are of solid material (either polycrystalline or amorphous), and the coating layers are extremely uniform in thickness.



**FIGURE 16**  
**Reflectivity vs. absorptance. This dichroic beamsplitter sample has high absorption in the UV.**

Due to advances in coating technology, some of these limitations have been greatly reduced. All interference coatings, unlike metal coatings or absorption glass, have a finite blocking range, but high energy coating technology maintains transmission while extending the blocking region. Filters produced by modified magnetron sputter technology, for example, have broader ranges of extinction by using sophisticated blocking strategies incorporated into the coating design. The extended blocking region using this coating process has a negligible effect on the transmission through the bandpass. The signal-to-noise ratio that this type of filter offers allow for the acquisition of high quality data in many photon-critical applications.

2) In traditional filter technology, the coating materials are limited in their range of transparency. Outside of this range, coatings become highly absorbing rather than highly transmissive or reflective. Some of the coating materials that are ideal for visible filters have excessive absorption in the UV, so materials with different and less-than-ideal characteristics must be used for UV filters. As a result, UV filters tend to have more limited performance and less design flexibility. Another consequence is that one cannot always calculate the reflectivity from a transmission spectrum by assuming zero absorption in the wavelength range shown in the spectrum. **Figure 16** is an example of a dichroic beamsplitter designed for high reflectivity in the visible only. The drop in transmission in the UV is a result of absorption instead of reflection. In general, one cannot assume that a beamsplitter designed to reflect the visible will also reflect the UV. Filters produced with newer high energy coating technology use materials with broader ranges of transparency in the violet and near UV.



**FIGURE 17**  
**Schematic representation of an acousto-optical tunable filter. (From Brimrose Corp.)**

3) As noted on page 9, interference coatings are sensitive to angle of incidence. As the angle is increased, the spectral characteristics of the coating shift to shorter wavelengths, i.e., the spectrum is "blue-shifted."<sup>14</sup> In addition the polarizing effect of coatings at oblique angles of incidence is undesirable in most applications. Although the coating designer can minimize the polarization, it cannot be eliminated entirely. This effect is, however, utilized advantageously in some special applications.

### Acousto-Optical Filters

The acousto-optical tunable filter (AOTF), shown schematically in **Figure 17**, is most often used for filtering excitation light, especially laser excitation. This filter works by setting up radio-frequency acoustical vibrations in an appropriate crystal and creating, in effect, a bulk transmission diffraction grating. By varying the frequency, one can rapidly tune the filter to diffract out with high precision any wavelength of light within the useful range. A typical AOTF will accept incident light with a maximum half-cone angle of approximately 5 degrees. The AOTF is an electronically controlled device that uses an external control unit.

<sup>14</sup> The effective physical thickness of the thin-film coating does indeed increase with increasing angle of incidence, but the difference in path length of the interfering reflected light rays decreases.

---

**Advantages of the AOTF include:**

- 1) the ability to change to any wavelength within microseconds, perform wavelength scanning, and generate multiple-band filtering by mixing multiple radio frequencies; and
- 2) the ability to rapidly vary the intensity by changing the amplitude of the acoustic vibrations.

**Some disadvantages include:**

- 1) limited FWHM (approximately 2 nm in the visible), which restricts the available light output from white light sources when the AOTF is used as an excitation filter;
- 2) limited physical dimensions such as a small aperture (approximately 10 mm or less) and a large overall thickness of approximately 25 mm; and
- 3) linearly polarized output, giving a maximum of 50% T when using unpolarized incident light.

**Liquid Crystal Tunable Filters\***

The liquid crystal tunable filter (LCTF) is another electronically controlled device that is finding increasing use as an emission filter because it works on a principle that enables imaging-quality filtering with an ample clear aperture and an in-line optical path. At the heart of the LCTF are a series of waveplates, each composed of a layer of birefringent material paired with a liquid crystal layer and sandwiched between linear polarizers. The birefringence of the liquid crystal layer, and thus the total magnitude of the waveplate, is fine-tuned by varying the voltage applied to transparent conductive coatings adjacent to the liquid crystal layer.

Briefly, the birefringence of the waveplate induces a wavelength-dependent rotation of the incoming polarized light. The second polarizer then attenuates the polarized and rotated light to varying degrees, in effect converting the rotation into an amplitude variation which is also wavelength-dependent. The LCTF designer is able to control filtering parameters by varying structural aspects such as the number of waveplates in series and the birefringence qualities of each waveplate.

**Characteristics of LCTFs include:**

- 1) a speed of wavelength selection on the order of milliseconds;
- 2) no wavelength-dependent image-shift;
- 3) variable attenuation capabilities; and
- 4) a choice of bandwidths (FWHM), spectral range of tunability, and blocking level, although these parameters are somewhat interdependent.

LCTFs are polarizing optical components, so the maximum peak transmission for unpolarized light is fifty percent. Existing devices can have significantly less than fifty percent, depending on wavelength and blocking level. However, the use of special polarizing beamsplitters in an epi-fluorescence microscope can mitigate the overall effect of these losses. The maximum blocking level commercially available is around  $10^{-5}$ .

\* See references on page 31

## DESIGNING FILTERS FOR FLUORESCENCE MICROSCOPY

The primary goal of filter design for fluorescence microscopy is to create filter sets (typically an excitation filter, emission filter, and dichroic beamsplitter) that maximize image contrast and maintain image quality.

Image contrast is a combination of several factors: 1) the absolute brightness of the image; 2) the brightness of the fluorescing substance relative to the background, known as **signal-to-noise ( S/N )**; and 3) to a lesser extent in the case of visual or photographic observation, the color balance as perceived by the eye. Filters must have high throughput (i.e., wide bandwidth combined with high transmittance), as well as low cross-talk, because no amount of improvement in S/N will improve the image contrast if the image is not bright enough to be adequately detected. In addition, the best way to achieve maximum contrast often depends on the specific application or technique, so the filter designer should have a conceptual understanding of these various applications. How the filter designer incorporates the available information regarding a particular application is described in detail below.

Image quality is maintained by ascertaining the optical quality requirements at each point in the microscope where a filter is inserted, and ensuring that each filter is manufactured to the correct specifications. In order to ascertain these requirements, one must be well grounded in the fundamentals of microscope optics and have an understanding of the requirements of particular applications and techniques. This is especially true today, with the growing number of applications that are taking advantage of the newest technologies: lasers for both illumination and sample manipulation, digital image processing, computer-assisted positioning and controls, and ultrasensitive detection devices.

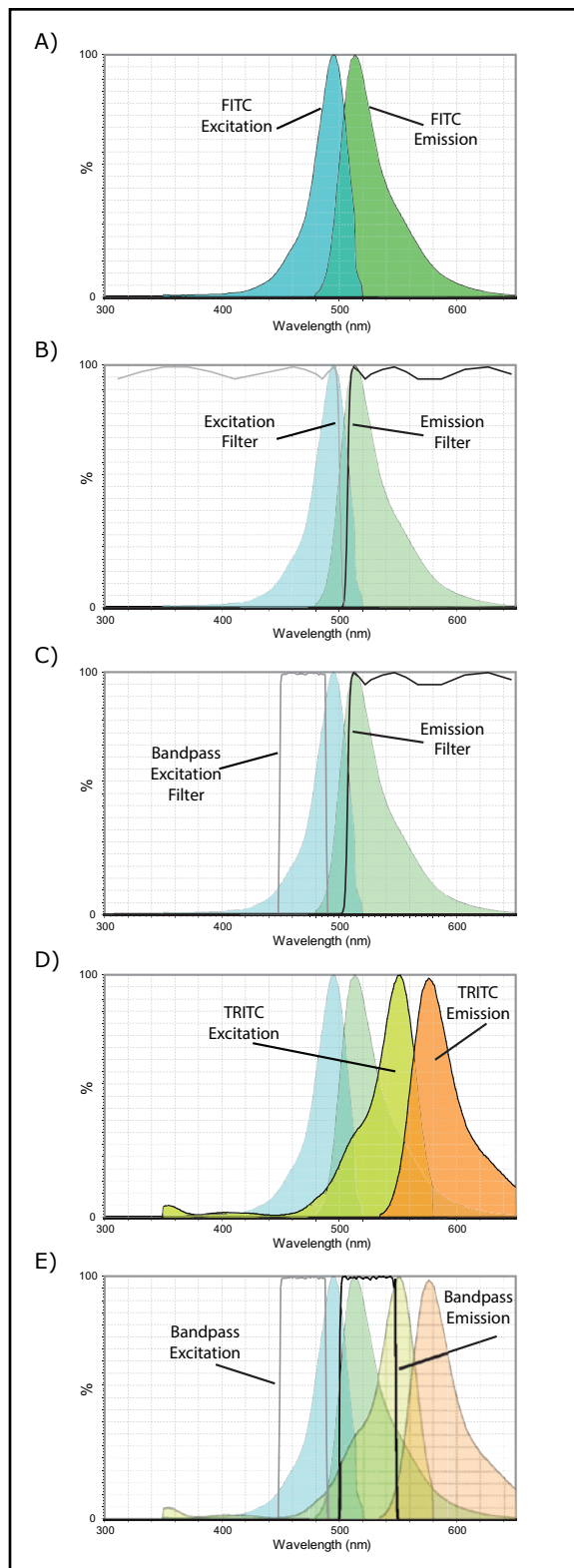
In addition, the filter designer must be aware of all the physical dimensions required by the various microscope brands and models.

### IMAGE CONTRAST

The general process by which a filter set is optimized for a particular fluorochrome can be illustrated by taking as an example a specimen stained with the dye FITC and explaining how filters are designed for this dye.

### Fluorescence spectra

The single most important parameter for designing a filter set is the spectral characteristic of the dye, with excitation and emission spectra shown in **Figure 18A**. If this were the only parameter to be considered,



**FIGURE 18**  
A) FITC excitation and emission spectra  
B) Perfect filter pair for FITC, overlaid on excitation and emission spectra  
C) Filter pair with bandpass excitation filter specific to FITC  
D) TRITC excitation and emission spectra, overlaid on FITC spectra  
E) Bandpass filter pair for FITC (Chroma Technology Corp P/N 49002), overlaid with excitation/emission spectra for FITC and TRITC



one would illuminate the specimen using a shortpass excitation filter that transmits all of the excitation spectrum and observe the fluorescence using a longpass emission filter that transmits the entire emission spectrum. A pair of filters for FITC having these characteristics is shown in **Figure 18B**. These represent “ideal” shortpass and longpass filters; real filters would need a wider separation between the cut-on and cut-off because of slope limitations of filters, and the shortpass excitation filter would have a cut-off point somewhere in the UV.

But in a real specimen there are other considerations. Many substances in the specimen are likely to autofluoresce if a shortpass excitation filter is used, especially one that transmits UV light. Tissue specimens for pathology are especially prone to autofluorescence. Also, the presence of UV light, which has higher intrinsic (i.e., quantum) energy, might increase the rate of photobleaching of the fluorochrome and/or cause photodamage to the specimen. Therefore, one should limit the band to a region where the FITC excitation is at a maximum, but still wide enough to allow adequate intensity, using a bandpass excitation filter as shown in **Figure 18C**.

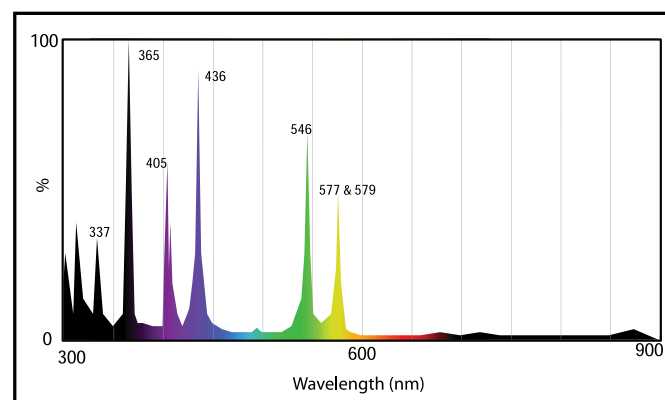
If a second fluorochrome is included in the specimen, for example TRITC with excitation and emission spectra as shown in **Figure 18D**, there is low but significant excitation efficiency in the blue for this dye. If a longpass emission filter is used for the FITC, a small but noticeable orange emission from TRITC might be seen. This is usually considered an undesirable effect, especially when imaging with a monochrome camera that does not distinguish between colors. In this case, one should restrict the FITC emission filter to a narrower band (**Figure 18E**) that is more specific to the band of peak emission for FITC. The filters in **Figure 18E** are examples of Chroma's 49-series ET filters.

For cytometric applications where image brightness is not critical, even more narrow bands are often used in order to maximize the selectivity between fluorochromes.

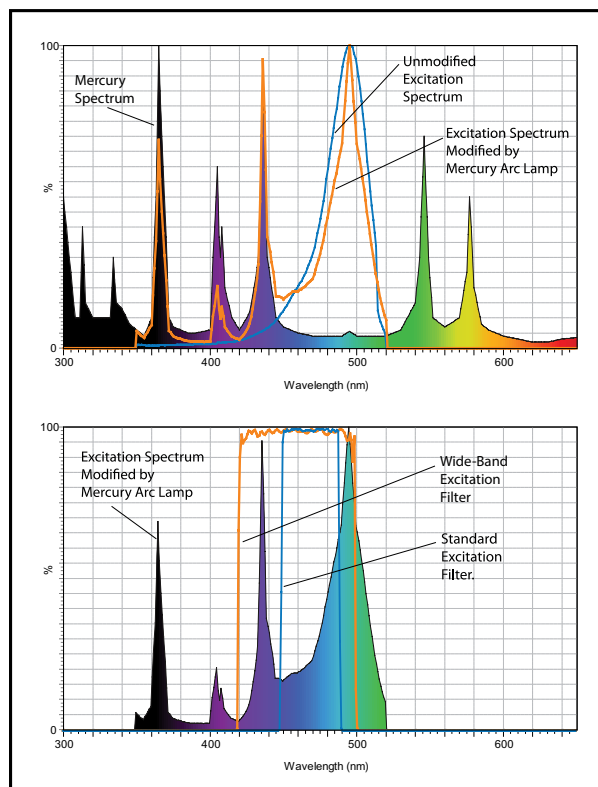
## Light sources

So far, a hypothetical light source having an equal output in all colors—a pure white light—has been assumed. Real light sources can have a wide variety of spectral output, and in many cases it is important to design filters with the type of light source in mind. Following is a list of light sources often used for fluorescence microscopy.

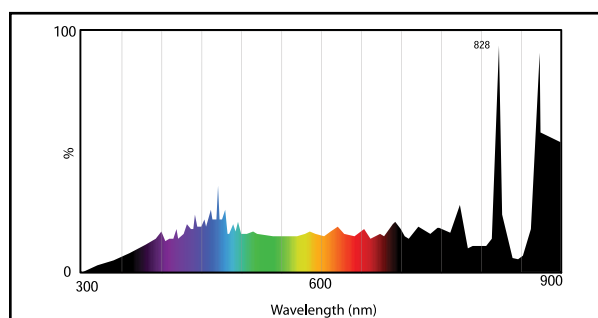
1) **Mercury arc lamps** are the most common light source for fluorescence microscopy, chosen for its high brightness (known technically as luminance or *radiance*) in the ultraviolet and visible spectrum. The spectrum of this light source (**Figure 19**) is far from continuous; most of its light output is concentrated in a few narrow bands, called lines, and each line is approximately



**FIGURE 19**  
Spectrum of a mercury arc lamp. (Mid-UV output below 300 nm is not shown.)



**FIGURE 20**  
**A) FITC excitation spectrum unmodified, and modified by the mercury arc lamp spectrum (normalized to 100% relative peak T).**  
**B) Modified FITC excitation spectrum overlaid with standard and wide-band excitation filters.**



**FIGURE 21**  
**Spectrum of a xenon arc lamp.**

10 nm wide. Most general-purpose filter sets should have excitation filters that transmit one or more of these lines, but there can be noticeable exceptions, one of which is illustrated in the following example. **Figure 20** shows the effect of modifying the excitation spectrum of FITC by the output of a mercury arc illuminator. A wide-band excitation filter that included the light at 436 nm would provide an emission signal significantly brighter than the filter that excludes this line. But for most specimens a reduction in overall S/N is to be expected because the increase in noise from autofluorescence will outweigh the increase in fluorescence signal. However, for certain applications involving extremely low absolute levels of fluorescence, or for specimens in which the FITC spectrum has been blue-shifted<sup>15</sup>, a wide-band excitation filter that includes the 436 nm line might provide improved detection. Note that the same emission filter would be used regardless of excitation band because the emission spectrum would not be significantly altered.

2) **Xenon arc lamps (Figure 21)**, have a relatively continuous spectrum in the visible. They are preferred in systems where the spectral characteristics of dyes and/or specimens are being analyzed quantitatively, but they are not as bright as a mercury lamp of equivalent wattage. Even in the region of FITC excitation (between 450 and 500 nm) where the mercury lamp is relatively weak, the xenon arc lamp is only marginally brighter. There are two main reasons for this. First, the light-producing arc of the xenon lamp is larger than the arc in the equivalent mercury lamp, which reduces the amount of available light that can be focused onto the specimen using a typical microscope configuration. Some relevant data concerning mercury and xenon arc lamps are given in **Table 1**. Note the differences in arc size between the lamps. Second, the xenon arc lamp has proportionally much greater output in the Near-IR as seen in **Figure 21**, as well as the IR.

This high IR output poses another disadvantage of the xenon arc lamp. Excitation filters must be designed to have excellent blocking in the Near-IR (>800 nm,) and depending on the location of the filter, they must be designed to withstand higher thermal loads.

3) **Metal-halide short-arc lamps** are used increasingly for fluorescence microscopy. Spectrally, there is significant variation in output between models. In general they are similar to mercury arc lamps, but with greater relative intensity between the main emission lines. In this respect they are similar to standard xenon arc lamps. Metal halide sources have significant advantages over traditional mercury and xenon arc lamps: a) they have a useful life up to 2000 hours, compared to 200 hour of the typical mercury illuminators and 400

<sup>15</sup> This shift can occur, for example, under conditions of low pH values (pH less than 6) (Haugland, 1992).

LAMP TYPE	RATED POWER (watts)	LUMINOUS FLUX (lumens)	AVERAGE BRIGHTNESS (candela/mm <sup>2</sup> )	ARC SIZE w x h (mm)	RATED LIFE (hours)
<i>Mercury</i>					
HBO 50W/3	50	1300	900	0.20 x 0.35	200
<b>HBO 100W/2</b>	<b>100</b>	<b>2200</b>	<b>1700</b>	<b>0.35 x 0.25</b>	<b>200</b>
HBO 200W/2	200	10000	400	0.60 x 2.20	400
<i>Xenon</i>					
<b>XBO 75W/2</b>	<b>75</b>	<b>1000</b>	<b>400</b>	<b>0.25 x 0.50</b>	<b>400</b>
XBO 150W/1	150	3000	150	0.50 x 2.20	1200

**TABLE 1**  
Data for xenon and mercury arc lamps. Boldface entries indicate most common sizes for fluorescence microscopes. (From Abramowitz, 1993)

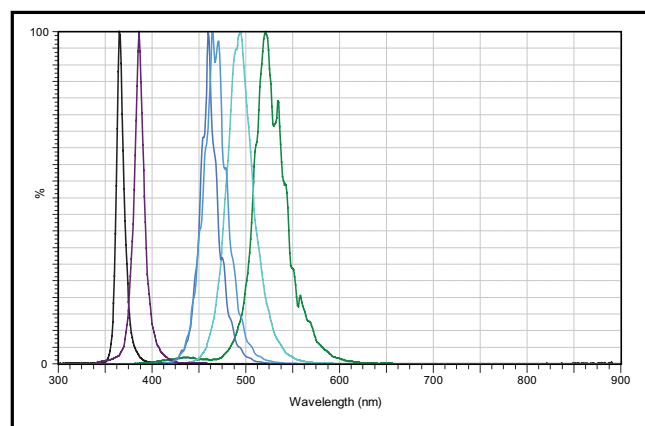
hours of the xenon lamps; and b) they are usually configured in a precisely machined housing with an integral elliptical reflector, making possible easy and stable alignment.

The main disadvantage is that due to larger arc size (the smallest size being approximately 1.2 mm) and limitations of optics of the elliptical reflector, the average brightness is similar to the xenon arc lamps. And like xenon arc lamps, they generally have higher output in the IR than the mercury arc lamp.

**4) Light-emitting diode (LED)** sources are also gaining in popularity, particularly in less expensive microscopes used in schools. LEDs are uniquely different than arc lamps in that they emit light within a relatively narrow spectral bandwidth, with FWHMs ranging from approximately 10 to 40 nm. **Figure 22** shows spectra for some typical LED sources. This is an attractive feature for fluorescence microscopy because the need for an excitation filter to have an extended blocking range is eliminated. In some applications using fluorochromes with large Stokes shifts an excitation filter might not even be necessary. However most applications use fluorochromes with narrow Stokes shifts and still require an excitation/emission filter pair.

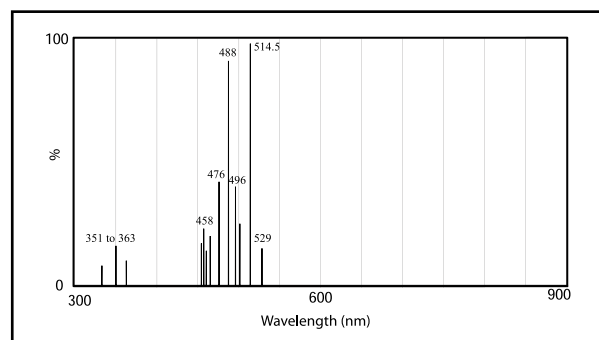
LED's have other significant advantages: a) LEDs are typically rated for at least 10,000 hours, with many lasting upwards of 50,000 hours; b) their output intensity remains relatively constant over the entire rated life; and c) since they are solid-state devices, their output (both on/off and intensity) can be controlled very rapidly, on the order of a millisecond.

A main drawback of LED sources that has limited their use in fluorescence microscopy has been their brightness. However, recent advances in LED technology have led to LED's that are approximately as bright as the arc lamps within the narrow spectral band emitted by the LED.

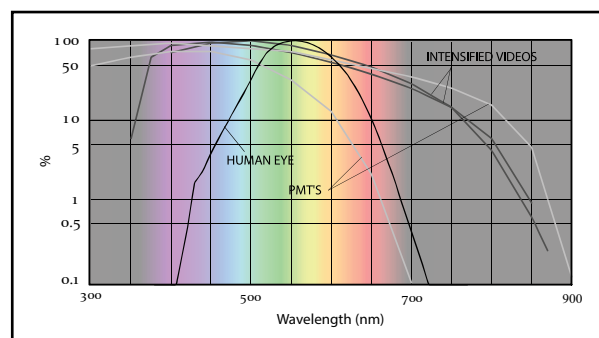


**FIGURE 22**  
Spectra for typical LED sources. Nominal wavelengths: 365 nm, 390 nm, 455 nm, 470 nm, 505 nm and 535 nm. (390 nm LED data from Nichia Corp.)

The main disadvantage now is, ironically, the narrow spectral emission band. This is for two reasons: a) for multi-channel applications, the output of several different colors of LED must be combined, necessitating relatively complex optical schemes that can limit overall brightness; and b) there are only a limited number of spectral bands available, especially one in the green spectral region that can match the very useful 546 nm mercury line.<sup>16</sup> One must also be aware that for any single LED color, there can be significant variability in peak wavelength from batch to batch (up to 20 nm,) as well as a wavelength dependence on the temperature and magnitude of the drive current used to power the LED (up to 5 nm.)



**FIGURE 23**  
Typical spectrum of an argon-ion laser. (Data from Spectra-physics Lasers, Inc.)



**FIGURE 24**  
Sensitivity of various detectors. Each spectrum is normalized to peak sensitivity. (Video and PMT data from Hamamatsu Corp.)

5) **Lasers** have become almost ubiquitous in confocal fluorescence microscopy because of their extremely high brightness over narrow (usually monochromatic) spectral bands. However, they are rarely used for wide-field fluorescence microscopy because the coherent nature of laser light makes it difficult to achieve a uniform illumination over the sample field. A detailed discussion of filter design for laser illumination can be found on page 25.

## Detectors

The excitation filter must be designed to block any out-of-band light that can be picked up by the detector. Arc lamps and filament lamps have output throughout the near-UV, visible, and IR, so the filter must have adequate attenuation over the whole range of sensitivity of the detector. But for laser illumination, the blocking range of excitation filters need only cover the range of output of the laser. For example, IR blocking is not required for the argon-ion laser (**Figure 23**).

**Figure 24** shows some sensitivity spectra of important detectors. Not shown is the sensitivity of unintensified silicon photodiodes or CCDs, which have sensitivity to 1100 nm, falling to zero by 1200 nm. Note that silicon detectors that are intensified with, for example, a microchannel plate, have sensitivity ranges similar to the intensified video spectra shown in **Figure 23**.

In general it is preferable to block out-of-band light with the excitation filter instead of the emission filter for three reasons: 1) the specimen will be exposed to less radiation; 2) fewer components in the emission filters generally improve its optical imaging quality; and 3) many microscopes have shallow cavities for holding emission filters, so it is beneficial to eliminate components that add to the finished thickness. There are certain cases, for example UV excitation, where the process of extending the blocking of the excitation filter greatly reduces the peak transmission of the filter. In these cases it would be appropriate to provide extended IR blocking in the emission filter instead.

<sup>16</sup> The recent use of conversion phosphors has helped to overcome this limitation. Conversion phosphors are coatings that are added to LED systems that absorb the LED light and emit light at a longer wavelength. Phosphors having output spectra that better match the excitation spectra fluorochromes can be selected.

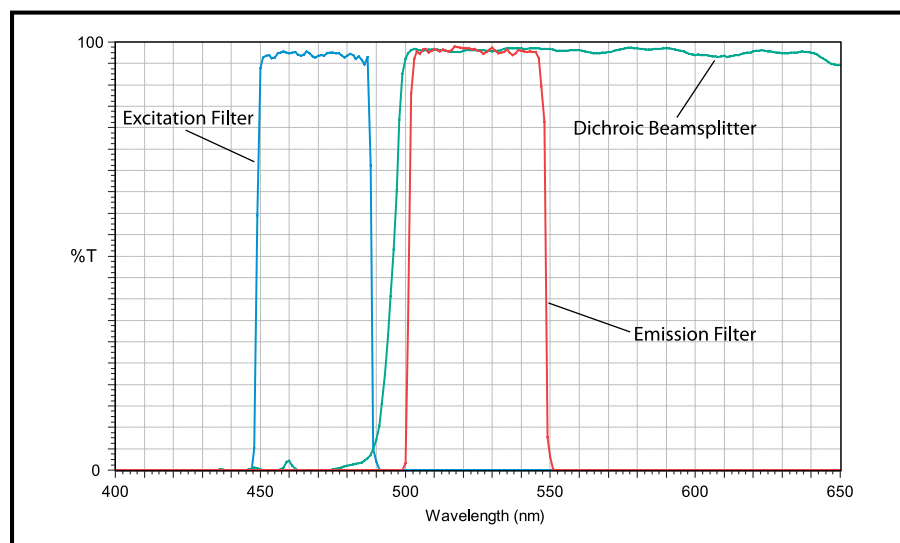
When doing visible photographic work, it is important to have IR blocking because some built-in light meters have IR sensitivity that could affect exposure times.

## Beamsplitters

The final stage in the design of a filter set is to select a dichroic beamsplitter that matches the spectra of the excitation and emission filters. Beamsplitters having both high reflectance of the excitation band and high transmittance of the emission band not only maximize the signal but also improve contrast by further reducing background noise. Reflectance of greater than 95% of the excitation band, with average transmission greater than 95% in the emission band, can now be achieved with advanced coating technology such as modified magnetron sputtering.

At the relatively high angle of incidence of 45 degrees, the coatings can be highly polarizing, so the designer must work to minimize this effect. Beamsplitters for imaging systems, such as microscopes, usually consist of one or two coatings applied directly onto the glass substrate, so extra care in handling is advised. The surface that is designed to face the light source and specimen is called the *front surface* of the beamsplitter. Determining which is the front surface can be difficult, so the manufacturer usually provides some type of marking to indicate the correct orientation.

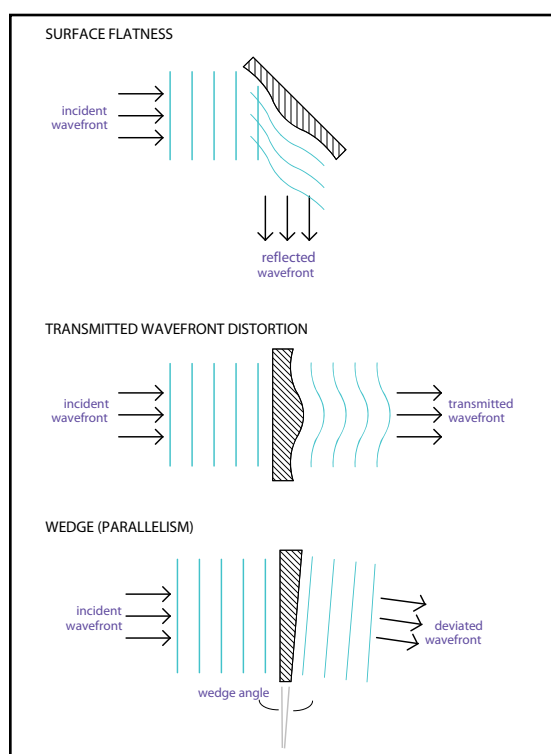
**Figure 25** shows a completed design for a filter set for FITC, including excitation filter, emission filter, and dichroic beamsplitter matched to these filters.



**FIGURE 25**  
Completed filter set design for FITC (Chroma Technology Corp P/N 49002)

## OPTICAL QUALITY

The optical quality requirements for an optical filter depend very much on such factors as the type of filter (especially whether it is a component of the illumination optics or the imaging/detection optics), the type of microscope, and the intended application. For example, the optical quality specifications for an emission filter used for quantitative image analysis with a laser scanning confocal microscope are much different from those for an excitation filter used for qualitative visual observation with a standard wide-field microscope. Although specific requirements for every type of filter and every application cannot be described here, by introducing the key optical quality parameters and analyzing a few basic microscope configurations, one can develop a set of general guidelines that can be applied to most situations.



**FIGURE 26**  
Illustration of the effects of surface flatness,  
transmitted wavefront distortion, and wedge.

### Optical quality parameters

The following is a list of important parameters used to define the overall image quality of a filter or beamsplitter. The first three parameters are illustrated in **Figure 26**.

1) **Surface flatness** is a measure of the deviation of the surface of an optical element from a perfect plane, usually measured in fractions or multiples of a wavelength of visible light (usually 550 or 630 nm, but sometimes using the CWL for a bandpass filter). The actual reflected wavefront distortion (RWD) that a plane wave of light undergoes when reflected from the surface is twice the value of the surface flatness.<sup>17</sup> It should be noted, however, that specifications using the term "RWD" are usually interpreted as the surface flatness of the substrate at normal incidence, because this is the standard configuration when measuring with a commercial interferometer. If the specification must truly be for RWD and not flatness, then this should be clearly noted.

The RWD of light reflected off a beamsplitter or mirror is solely determined by the surface flatness of the reflecting surfaces, usually just the front surface.

2) **Transmitted wavefront distortion (TWD)** is a measure of the distortion a plane wave of light undergoes when transmitted through an optical element, also measured in fractions or multiples of a wavelength of light, the same as for surface flatness, described above. The surface flatness of the outer surfaces of the element and, to a lesser degree, internal structures that cause inhomogeneity of the refractive index, combine to make up the overall TWD of the optical element.

3) **Wedge** (also called *parallelism*) is a measure of how parallel are the outer surfaces of an optical element. Wedge is usually measured in arc-minutes or arc-seconds of angle. The main effect of wedge is to induce an angular

<sup>17</sup> This is strictly true only for light reflected at normal incidence. The value for light reflected at non-normal incidence is modified by a cosine factor. For example, the reflected wavefront distortion at 45 degrees angle of incidence is approximately 1.4 times the surface flatness.

---

deviation in the direction of a light beam, causing, for example, image shifting. The amount of *angular deviation* is about one-half the wedge angle for a typical filter.<sup>18</sup> The wedge of internal coating surfaces, while not contributing greatly to beam deviation, can cause noticeable ghost images as a result of off-axis internal reflections.

4) The **clear aperture** of optical filters should not restrict the overall aperture of the microscope. It is also of critical importance that there is no leakage of unfiltered light around the edge of the clear aperture. Filter manufacturers usually sell filters in rings to ensure there is no leakage. If a filter is purchased without a ring, it is usually the responsibility of the customer to install the filter in a way that eliminates leakage.

5) **Scratches and digs** are measured in terms of mil-spec standards; e.g., "80/ 50 scratch/dig." The term *digs* includes such things as particles and small bubbles embedded inside a filter and macroscopic inclusions in exposed coatings.

6) **Pinholes** are small breaks in the coating of an interference filter, usually caused by the presence of dust particles on the substrate during coating. Pinhole size must be measured against standard maximum-tolerance pinholes under specific conditions using a high-intensity illuminator.

## Optical quality requirements for wide-field microscopes with Köhler illumination

Most fluorescence microscopes are *wide-field* epifluorescence systems that utilize Köhler illumination (illustrated in **Figure 3**, on page 4). Following is a brief description:

In Köhler illumination, two adjustable diaphragms are provided for control of the light beam: the *aperture diaphragm* that gets imaged onto (i.e., is conjugate to) the back aperture of the objective, and the *field diaphragm* that gets imaged onto the in-focus specimen plane. The field diaphragm is positioned near the lens that images the aperture diaphragm onto the objective back aperture. The collector lens assembly focuses the arc lamp onto the aperture diaphragm and thus onto the objective back aperture. Three essential effects are achieved with this configuration: 1) the image of the arc lamp is completely out of focus at the specimen plane, thus creating a uniform field of illumination; 2) the image of the field diaphragm appears in sharp focus on the specimen, and it can be adjusted to precisely fill the field of view or isolate any part of it; and 3) the numerical aperture of the illuminating beam can be adjusted (by adjusting the aperture diaphragm) without affecting the size of the illuminated field.<sup>19</sup>

With this in mind, some observations can be made regarding optical quality requirements for this type of microscope.

<sup>18</sup> For small angles of incidence, the angular deviation =  $(N - 1) \alpha$ , where  $N$  is the refractive index of the glass in the filter, and  $\alpha$  is the wedge angle. Most filters use optical glass with a refractive index of approximately 1.5.

<sup>19</sup> For an in-depth description of Köhler illumination optics, please refer to Inoué (1986) or literature from the microscope manufacturers.

---

1) The illumination optics of the microscope are designed for uniform illumination of the specimen with minimal flare, and not necessarily for faithful imaging of the light source or apertures. Therefore, excitation filters do not require transmitted wavefront distortion of imaging quality,<sup>20</sup> but only what is generally considered the industry standard of optical quality. Likewise, the surface flatness of the dichroic mirror does not require imaging quality.

2) Variations in the alignment of the beamsplitter inside the filter cube assembly will produce noticeable shifts in the position of the illumination spot (i.e., the image of the field diaphragm on the specimen plane) when switching filter cubes. For typical applications, an alignment of 45 degrees plus or minus three arc-minutes is considered adequate. (Because the angle of the reflected beam is always equal to the angle of the incident beam, the overall angular deviation caused by this alignment tolerance would be twice this, i.e., plus or minus six arc-minutes.) When filter cubes are supplied with the beamsplitter premounted, it is the responsibility of the supplier to properly align the beamsplitter. In addition, care must be taken to ensure proper alignment when the filter cube is installed into the microscope.

In contrast, variations in alignment have little effect on the apparent position of the image in the field of view, known as *registration shift*.

3) Similarly, the effect of angular deviation induced by wedge in the excitation filter will be a shift in the position of the illumination spot, but there will be no registration shifts of the image itself. Wedge must be controlled only to within alignment tolerances of the dichroic mirror mounted in the filter block assembly.

4) Filters in the image path, including the dichroic beamsplitter as well as the emission filter, generally *do* require transmitted wavefront distortion of imaging quality.

5) The effect of wedge in the emission filter and beamsplitter will be a registration shift of the image when switching filters or cubes. Wedge must be controlled in these components.

In addition, variations in the thickness of the beamsplitter might cause registration shifts. The extent of this thickness-related shift depends on the microscope: epifluorescence microscopes with *standard tube-length* optics have a light beam in the imaging path that is not collimated.<sup>21</sup> They are therefore more sensitive than microscopes with *infinity-corrected* optics that have, in principle, collimated light in the image path.

<sup>20</sup> The term "imaging quality" denotes a level of optical quality that will not degrade the overall performance of a specific optical system. For a typical microscope, a TWD of 1 wave per inch is generally considered adequate for optical filters and beamsplitters.

<sup>21</sup> Most modern microscopes of this type have relay lenses in the filter-block housing that improve the collimation inside the cube. The sensitivity is reduced but not eliminated entirely.



The wedge and, to a lesser extent, the thickness of the dichroic beamsplitters and the emission filters must be tightly controlled for filter sets that require sub-pixel registration (SPR). The optical-quality requirements for SPR filter sets is discussed in more detail on page 24.

6) Since the excitation filter is usually positioned near the field diaphragm (a point conjugate to the image plane in Köhler illumination), pinholes in the excitation filter are very noticeable and must be eliminated.

7) Autofluorescence of the dichroic beamsplitter must be minimized because this is the one element that is both fully illuminated by excitation light and part of the optical path of the image.

It is important to note that the beamsplitter requires separate and independent specifications for surface flatness and transmitted wavefront distortion.

Based on the above observations, some typical optical quality specifications for filters used in **wide-field epifluorescence** microscopes are listed in **Table 2**.

OPTICAL QUALITY PARAMETER	FILTER TYPE		
	EXCITATION	EMISSION	BEAMSPLITTER
Surface flatness	no specification	no specification	<10 waves per inch
Transmitted wavefront	no specification	1 wave per inch	1 wave per inch
Wedge	<6 arc-minutes	1 arc-minute	1 arc-minute
Scratch/dig	80/50	60/40	40/40
Pinholes	none	minimal	no specification*
Autofluorescence	no specification	moderate control	minimal

\*Measured as a dig using scratch/dig specifications.

**TABLE 2**  
Typical optical quality specifications for filters in a wide-field epifluorescence microscope.

## FILTER SETS FOR SUB-PIXEL REGISTRATION

*A common method for imaging specimens with multiple fluorochromes is to record images of each fluorochrome separately, using a high-resolution monochrome CCD camera. The separate images are then pseudo-colored and overlaid into a single image. Images are obtained using a different filter "cube" for each fluorochrome. The matched set of filter cubes are installed in a multi-position slider or turret.*

*Some applications, in particular those that involve co-localization analysis, require the separate images to be registered to within one pixel. Filter sets that are manufactured to have this level of image registration are called **sub-pixel registration (SPR)** filter sets.*

As described above, the primary cause of a shift in image registration is the wedge of the dichroic beamsplitter and the emission filter. Although the specific requirements for achieving SPR depend on the optical layout of the microscope and the type of CCD detector, typical specifications for wedge are 2 arc-seconds for beamsplitters and 10 arc-seconds for emission filters. The wedge specification for the beamsplitter is typically lower for two reasons:

- 1) the angular deviation induced by a substrate at 45 degrees AOI is greater than at normal incidence, and
- 2) beamsplitters are always composed of a single substrate that can be controlled readily for wedge.

A secondary cause of image shift can be the thicknesses of the emission filter and dichroic beamsplitter. As noted above, the extent of this thickness-related shift depends on the microscope: epifluorescence microscopes with standard tube-length optics have a light beam in the imaging path that is not collimated, and therefore are more sensitive to thickness differences than microscopes with infinity-corrected optics, which have more collimated light in the image path where the filter cube is located. Thickness variations of 0.2 mm or less between emission filters in a set, and likewise 0.2 mm or less between beamsplitters, should eliminate this effect.<sup>22</sup>

Another secondary cause of image shift can be the flatness of the dichroic beamsplitter. Thin-film interference coatings in have intrinsic mechanical stress that will cause a substrate to warp. The amount of stress is heavily dependant on the coating process. Some processes such as magnetron and ion-beam sputter deposition, make coatings with very high stress, enough to noticeably warp a thin substrate. If the light beam in the imaging path is not collimated, this warpage can induce a significant image shift. This effect may be noticeable if all dichroic beamsplitters in the sets that are installed in multi-position slider or turret are not made by the same deposition process.

<sup>22</sup> This assumes that the refractive indices of the glass substrates used in the filters are similar.

## FILTERS FOR CONFOCAL MICROSCOPY

When designing filters for use in confocal fluorescence microscopes (CFMs), one must consider primarily the optical configuration of the microscope. Almost every make and model of CFM has a unique configuration and therefore a unique set of optical specifications, but most systems can be grouped into one of two basic categories: CFMs that utilize a Nipkow-disk mechanism for scanning the specimen, and those that scan with a laser beam. The optics used in each of these scanning methods are briefly described below by comparing them to the optics of a standard widefield microscope. For a more detailed analysis of CFM optics, such as depth of field, resolution, and image generation techniques, please refer to the literature available from the CFM manufacturers, as well as articles published in scientific journals associated with microscopy or laboratory techniques for biology and genetics.

### OPTICAL QUALITY REQUIREMENTS FOR CONFOCAL FLUORESCENCE MICROSCOPES

#### Nipkow-Disk Scanning CFMs

Figure 27 is a schematic illustration of a CFM with broad-band arc lamp illumination, a Nipkow-disk scanning mechanism, and an image detector, either a camera or direct visual observation.

This microscope has an optical path similar in principle to standard wide-field scopes (illustrated in Figure 3). The disk is set in a position conjugate to the specimen plane and must be uniformly illuminated over the entire field of view, usually with Köhler illumination. Therefore the transmitted wavefront requirements for the excitation filter and the surface flatness requirement for the dichroic beamsplitter are the same as for the wide-field microscope. Similarly, the transmitted wavefront requirements for the emission filter and beamsplitter are the same as for the wide-field microscope. The wedge requirements for the various filters are, in general, also unchanged, although variations in the focal length of specific CFM designs might necessitate modifications of these specifications.

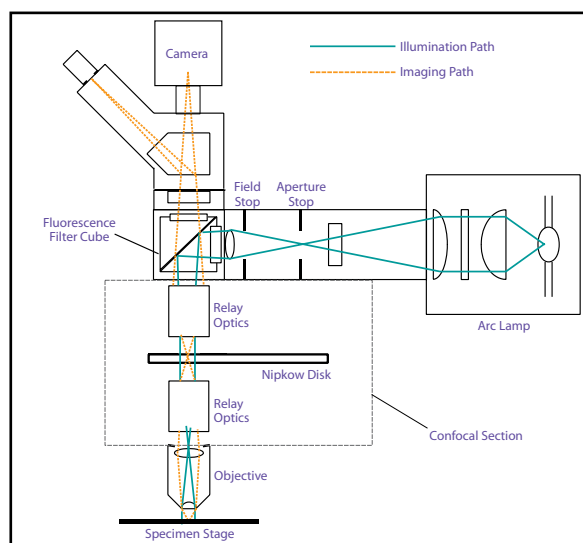
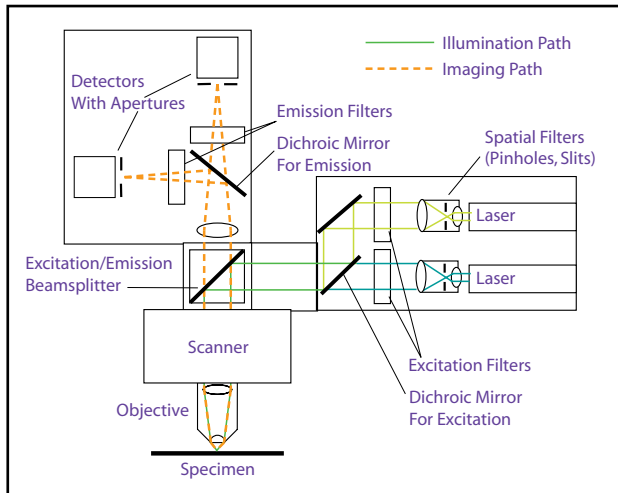


FIGURE 27  
Schematic of a confocal fluorescence microscope with Nipkow-disk scanning.



**FIGURE 28**  
Schematic of a laser scanning confocal fluorescence microscope.

## Laser Scanning CFMs

**Figure 28** is a schematic illustration of a CFM with laser illumination, a moving-mirror scanning mechanism, and photometric detection such as a photomultiplier tube (PMT). The optical paths in this microscope design are significantly different from those in wide-field microscopes. The two major differences are:

- 1) the pinhole (or slit) in the illuminator is imaged onto the specimen plane via *critical illumination*, with the laser spot being directly focused onto the sample; and
- 2) the image is formed by synchronously matching the train of electrical signals generated by the detector to the position of the laser beam on the specimen, similar to the image-forming mechanism of a television set. The electrical signals from the detector correspond to the variations in the intensity of the fluorescence signal that passes through the conjugate pinhole (or slit) aperture.

In this configuration the laser beam must remain undistorted in order to achieve the best focus at the specimen plane, and there must be minimal angular deviation from the true optical path. In addition, most CFMs of this type have relatively long optical path lengths that can magnify any angular deviations introduced by a filter. Therefore, the excitation filters and beamsplitters require a degree of optical quality and registration equal to or greater than that required for emission filters and beamsplitters. Most systems have transmitted wavefront distortion and surface flatness specifications on the order of one wave per inch for excitation filters and beamsplitters. The wedge specifications are similarly tighter, typically one arc-minute or less, in order to minimize alignment adjustments when switching filters.

In the emission optics, any components that are located between the objective and the detection aperture must be of imaging quality. In the example illustrated, this includes all of the emission filters and beamsplitters shown. Some systems might use a single aperture that would be located between the main excitation/emission beamsplitter and the detection unit. In this case, the optical requirements for the filters within the detection unit might be less critical.

## SPECTRAL REQUIREMENTS FOR CONFOCAL FLUORESCENCE MICROSCOPES

Any unique spectral requirements generally stem from the type of illumination and detection in the microscope. Since the illumination and detection systems of Nipkow-disk scanning CFMs differ from those of laser-scanning CFMs, most can again be grouped into one of these two categories.

### Nipkow-Disk Scanning CFMs

Since the light source and the detection system of this configuration (described above and illustrated in **Figure 26**) are the same as for standard wide-field

---

EFMs, the spectral requirements are basically the same, with one exception: because of reduced signal intensity and the addition of extra optical elements, each of which produces undesirable reflections and scattering, excitation and emission filter pairs must have very low cross-talk.<sup>23</sup> In addition, extra care is required in the quality control of pinholes in the filters.

### Laser Scanning CFMs

Filters and beamsplitters for this configuration (described above and illustrated in **Figure 27**) are designed to work optimally for the specific laser being used. The most common lasers are now the solid state lasers, including laser-diodes (LDs) and diode-pumped solid-state (DPSS) lasers. There is a wide selection of laser wavelengths now available throughout the visible spectrum. More traditional lasers, such as the argon-ion, illustrated in **Figure 22**, the helium-neon, and argon-krypton are also used. When designing filters for use with lasers, the following considerations must be made:

1) Excitation filters must have a blocking range that covers the entire output spectrum of the laser. While filters that block to 800 nm are suitable for traditional laser sources, the DPSS lasers often have residual output at the NIR wavelengths used in the laser, particularly 1064 nm, that may fall within the response range of the detector. One special consideration regarding the filtering of laser excitation is that excitation filters for lasers should attenuate as much as possible by reflection in order to reduce the thermal load on the filter. For example, UV excitation filters for argon-ion lasers should have high reflectivity in the blue-green region of the visible spectrum where most of the laser power is concentrated.

2) The lasers used in most CFMs are polarized, so knowledge of the polarization conditions is very useful when designing beamsplitters for optimum performance. The dichroic beamsplitter illustrated in **Figure 9**, for example, was optimized for use in S-plane orientation with the 488 nm argon-ion laser line, enabling the beamsplitter to have greater throughput in, for example, a band of fluorescent emission that cuts on at 500 nm. Note that fluorescent emissions are largely unpolarized even when the excitation light is polarized, so the beamsplitter must efficiently transmit the fluorescence in both planes of polarization. Knowledge of the polarization conditions is especially useful when designing multiple-band polychroic beamsplitters, which must have very narrow reflection bands in order to maximize the transmission of the emission signals.

3) Emission filters must have a blocking range on the short wavelength side of the band that includes all laser lines that might be used with the particular filter. Blocking on the long wavelength side is recommended for applications that use multiple probes, to improve selectivity between the probe signals. Here the range of blocking only needs to cover the range of the detector, which can be as short as 700 nm for some PMTs (**Figure 23**).

<sup>23</sup> Some systems utilize polarized optics to reduce the effect of these reflections.

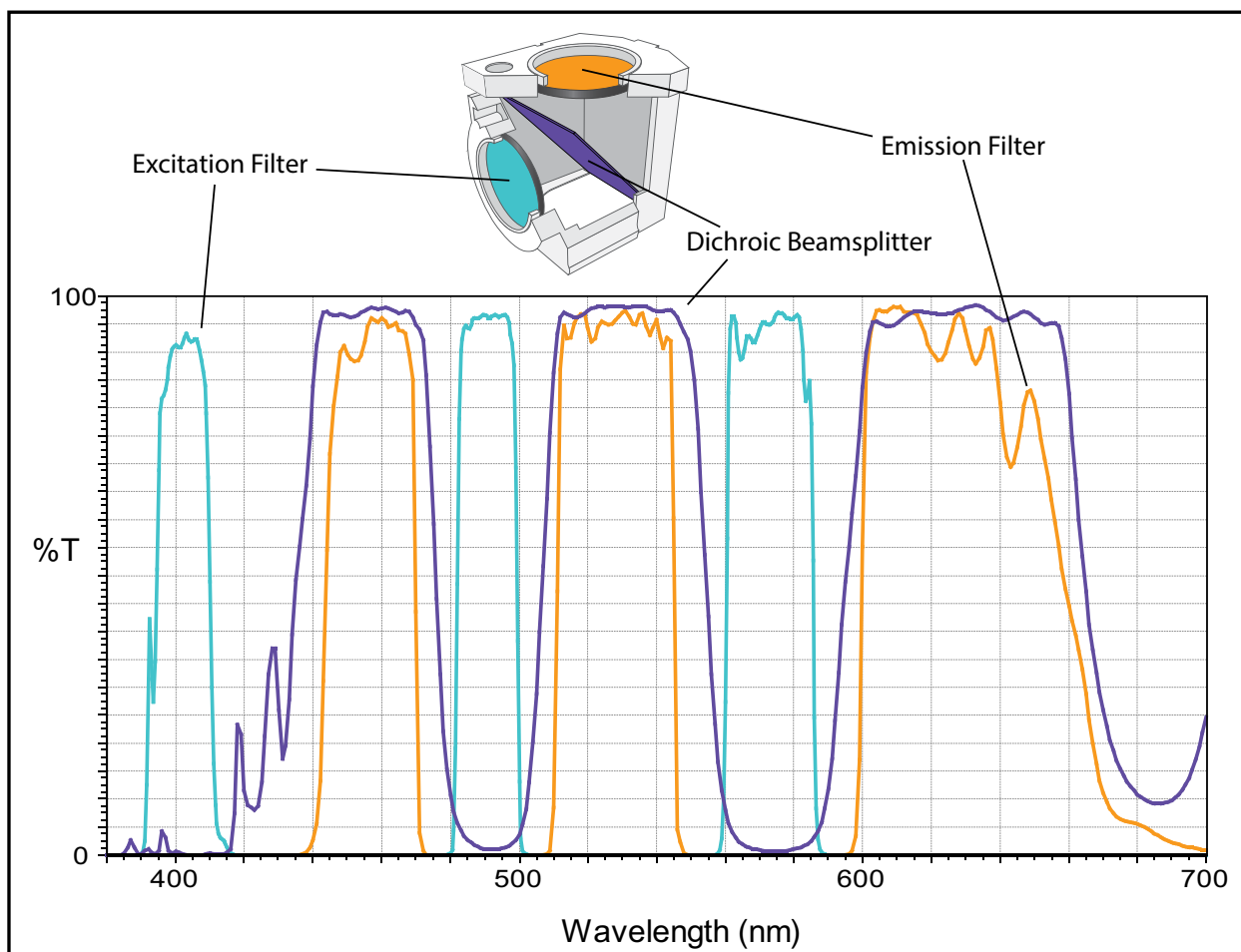
**TABLE 3**  
**Methods for applications using multiple probes.**

<b>METHOD</b>	<b>COMPONENTS</b>	<b>ADVANTAGES</b>	<b>DISADVANTAGES</b>
1. Separate single-band filter sets.	Standard microscope.	No extra equipment is necessary.  Brightest images.	Simultaneous imaging is not possible.  Imprecise imaging of combined images.
2. Multi-band filter sets.	Standard microscope.	Simultaneous visual observation with no registration errors.  No extra equipment is required (other than special filter set).	Reduced brightness.  Not recommended with xenon arc illumination.  Color balance is fixed.
3. Multi-band beamsplitter and emitter, single-band exciter.	Microscope with filter wheel or slider in the illumination path.  Photo camera, or electronic camera with image processing.	Sequential visual observation with no registration errors.  Precise registration of combined images; adjustable color balance.  Optimized exciters offer brighter image than method 2.	Extra equipment (a filter wheel or slider) is necessary.
4. Multi-band beamsplitter, single-band emitters and exciters, single camera.	Microscope with filter wheels or sliders in both the illumination path and imaging path.  Photo camera, or electronic camera with image processing.	Exciters and emitters can be designed to have brightness similar to method 1.  Reduction in registration error (by eliminating movement of the beamsplitter).	Extra equipment (two filter wheels or sliders) is necessary.  Registration errors between emitters might still be present.
5. Multi-band beamsplitter, single-band emitters and exciters, multiple cameras.	Microscope with filter wheel or slider in the illumination path.  Beamsplitter assembly for separating channels, each channel having a separate emission filter.	In addition to advantages in method 4:  Registration errors from emitters can be eliminated;  Additional applications are supported (e.g., ratio imaging).	More complicated apparatus requiring additional beamsplitters and cameras.
6. Neutral beamsplitter, replacing multi-band beamsplitter in methods 4 and 5.		Any valid combination of exciter and emitter can be used.	Brightness can be reduced by as much as 80%, so special light sources are recommended (e.g., laser illumination).

## FILTERS FOR MULTIPLE PROBE APPLICATIONS

When making a multiple-exposure photograph or multiple electronic images of specimens stained with several fluorochromes, using separate filter cubes in a standard microscope, there will be unavoidable registration shifts between exposures. Varying amounts of wedge in the emission filter and beamsplitter, variations in thickness and alignment of the beamsplitter, and mechanical vibration that occurs when the cubes are switched all contribute to this shift. Although for some applications these effects can be reduced to acceptable levels, many others require more sophisticated filter designs and optical apparatus.

Listed in **Table 3** are some available methods for applications involving multiple probes. These include the multi-band filter sets introduced earlier, illustrated in **Figure 29**, and various configurations that utilize both multi-band and single-band filter components. All of these methods are designed to eliminate the aforementioned registration errors. Method 2 offers the ability to visually observe up to three colors simultaneously. (Methods 3 through 6 can also do this if multi-band filters are added to the filter sets.) It should be noted that this list is only a guide, not an exhaustive list of all possible methods and configurations.



**FIGURE 29**  
Spectra of a triple-band filter set designed for the dyes DAPI, FITC, and Texas Red®.  
(Chroma Technology Corp P/N 69002)

---

## REFERENCES

**Abramowitz, M.** (1993) *Fluorescence Microscopy: The Essentials*. Olympus America, Inc.

**Brimrose Corp.**, Baltimore, MD. *AOTF Spectroscopy* (March 1993 catalogue).

**Ealing Electro-optics** (1992) Product Guide, Holliston, MA.

**Haugland, R.P.** (1992) *Handbook of Fluorescent Probes and Research Chemicals*, 5th ed. Molecular Probes, Eugene, OR.

**Inoué, S.** (1986) *Video Microscopy*. Plenum Press, New York.

**Kasten, F. H.** (1989) The origins of modern fluorescence microscopy and fluorescent probes. *Cell Structure and Function by Microspectrophotometry* (E. Kohen and J. G. Hirschberg, eds.). Academic Press, San Diego, CA.

**Lakowicz, J.** (1983) *Principles of Fluorescence Spectroscopy*. Plenum Press, New York.

**Schott Glasswerke.** Mainz, Germany. *Optical Glass Filters* (catalogue).

### References for Liquid Crystal Tunable Filters (p.13)

Cambridge Research and Instrumentation, Inc., Cambridge, MA. *Varispec Tunable Imaging Filter* (catalogue).

Morris, Hannah R., Clifford C. Hoyt, Peter Miller, and Patrik J. Treado (1996) Liquid crystal tunable filter Raman chemical imaging. *Applied Spectroscopy* **50**:806-808.

Hoyt, Clifford (1996) Liquid crystal tunable filters clear the way for imaging multiprobe fluorescence. *Biophotonics International* **July/August**.



---

## GLOSSARY

with page references

### **Acousto-optical tunable filter (AOTF) (p. 12)**

An active crystal device that works by setting up radio-frequency acoustical vibrations in the crystal and creating, in effect, a bulk transmission diffraction grating. By varying the frequency, one can rapidly tune the filter to diffract out a desired wavelength of light and transmit this wavelength out of the device.

### **Angle of incidence (AOI) (p. 9, fig. 9)**

The angle between the optical axis of the light incident on the surface of a filter and the axis normal to this surface.

### **Angular deviation (p. 21)**

A shift in the direction of light beam from the true optical axis of the system, measured in units of angle such as arc-minutes (1/60 of a degree) or arc-seconds (1/60 of an arc-minute).

### **Aperture diaphragm (p. 21)**

An adjustable diaphragm located in the illumination optics which controls the numerical aperture of the illuminating beam and affects the brightness of the beam.

### **Attenuation level (p. 8, fig. 6)**

*Also* Blocking level. A measure of the out-of-band attenuation of an optical filter over an extended range of the spectrum. The attenuation level is often defined in units of optical density (*see optical density*).

### **Autofluorescence (p. 2)**

In fluorescence microscopy, any fluorescence from substances other than fluorochromes, including primary fluorescence from the specimen, fluorescence from immersion oils and other media, and fluorescence from glass optical components within the microscope.

### **Average transmission (p. 8, fig.6A)**

The average calculated over the useful transmission region of a filter rather than over the entire spectrum. For a bandpass filter, this region spans the FWHM of the transmission band.

### **Background (p. 4)**

Any detectable light that is not a desired primary or indirect fluorescent emission. Sources of background include cross-talk between excitation and emission filters, light leaking through pinholes in filters, and electronic noise in cameras, as well as autofluorescence.

---

**Bandpass (p. 8, fig. 6)**

An optical filter that has a well-defined short wavelength cut-on and long wavelength cut-off. Bandpass filters are denoted by their center wavelength and bandwidth.

**Bandwidth (p. 8, fig. 6A)**

Also FWHM (Full width at half of maximum transmission). For optical bandpass filters, typically the separation between the cut-on and cut-off wavelengths at 50% of peak transmission. Sometimes a bandwidth at, for example, 10% of peak transmission is specified.

**Barrier filter**

*See* Emission filter.

**Blocking level**

*See* Attenuation level.

**Blocking range (p. 8, fig. 6B)**

The range of wavelengths over which an optical filter maintains a specified attenuation level.

**Blocker (p. 11, fig. 15)**

A thin-film interference coating that is incorporated into a bandpass interference filter to extend the blocking range of the primary coating in the filter. A blocker is usually a very wide-band bandpass filter having high transmission in the band of the primary filter.

**Brightfield (p. 6)**

A kind of diascope illumination in which the field of view is illuminated directly. Also, the type of condenser used for this kind of illumination.

**Center wavelength (CWL) (p. 8, fig. 6A)**

For optical bandpass filters, the arithmetic mean of the cut-on and cut-off wavelengths at 50% of peak transmission.

**Clear aperture (p. 21)**

The surface area of an optical filter which is free of any defects or obstructions. On interference filters the clear aperture is often delimited by an annulus of metal or opaque material.

**Critical illumination (p. 26)**

A type of illumination optics in which the image of the light source is focused onto the specimen plane, in contrast to Köhler illumination optics. *See also* Köhler illumination.

---

**Cross-talk (p. 9, fig. 7)**

The minimum attenuation level (over a specified wavelength range) of two filters placed together in series. The transmission spectrum of the beamsplitter is sometimes included in this evaluation.

**Darkfield (p. 6)**

A kind of diascopic illumination in which the specimen is illuminated obliquely, i.e., at angles that will not enter the objective directly. Also, the type of condenser used for this kind of illumination.

**Diascopic illumination (p. 6)**

Illumination using light transmitted through the specimen, using a condenser to focus the light.

**Dichroic beamsplitter (p. 5, 7 footnote, fig. 4)**

*Also* Dichroic mirror, Dichromatic beamsplitter. A special mirror housed in the filter cube that selectively reflects the excitation light filtered by the exciter and transmits the emitted fluorescence. Dichroic beamsplitters can also be found in any other part of a microscope system where light needs to be split or combined by wavelength.

**Edge filter (p 8)**

Another term for either a shortpass or longpass optical filter. The term usually denotes a filter with a very sharp cut-on or cut-off.

**Emission filter (p. 5, fig. 4)**

*Also* Barrier filter, Emitter. A color filter that attenuates all of the light transmitted by the excitation filter and very efficiently transmits any fluorescence emitted by the specimen.

**Emitter**

*See* Emission filter.

**Epifluorescence microscope (p. 4)**

A fluorescence microscope that illuminates the specimen episcopically (i.e., with light reflected onto the specimen).

**Episcopic illumination (p. 7)**

*Also* Incident-light illumination. Illumination with light reflected onto the specimen rather than transmitted through the specimen. The illuminating light is reflected through the objective by means of a beamsplitter that is either partially reflective or a dichroic.

**Excitation and emission (p. 2)**

*See* Fluorescence.

---

**Excitation filter (p. 5, fig. 4)**

*Also* Exciter. A color filter that transmits only those wavelengths of the illumination light that efficiently excites a specific dye. *See* Emission filter.

**Exciter**

*See* Excitation filter.

**Extinction coefficient (p. 3)**

A measure of the absorption characteristics of a fluorochrome.

**Fading**

*See* Photobleaching.

**Field diaphragm (p. 21)**

An adjustable diaphragm located in the illumination optics which controls the area of illumination on the specimen.

**Filter block**

*See* Filter cube.

**Filter cube (p. 5, fig. 4)**

A removable cube-shaped unit that holds a matched set of fluorescence filters. This set usually includes an excitation filter and emission filter but always includes a dichroic beamsplitter.

**Filter glass (p. 10)**

*Also* Absorption glass. Colored glass that is manufactured for technical and scientific applications. The most common types of filter glass used in fluorescence microscopy are UV-transmitting "black glass" filters; IR-absorbing heat filters; and yellow, orange, and red sharp-cut longpass filters. Filter glass selectively attenuates light by absorption, so the spectral performance is dependent on the thickness of the glass.

**Fluorescence (p. 2)**

A molecular phenomenon in which a substance absorbs light, then radiates part of this absorbed energy as light of another color, one of lower energy and thus longer wavelength. This process is known as excitation and emission. Fluorescence is distinguishable from other types of luminescence in that the process of excitation and emission occurs nearly instantaneously (i.e., on the order of nanoseconds).

**Fluorescent probe (p. 2)**

*Also* Fluorophore. A fluorochrome that has been conjugated to an active substance, such as a protein, antibody, or nucleic acid, in order to selectively stain a targeted substance within the specimen.

---

**Fluorochrome (p. 2)**

A fluorescent dye used either directly as a specimen stain or conjugated to an active substance to make a fluorescent probe.

**Fluorophore**

*See* Fluorescent probe.

**Front surface (p. 19)**

The side of a beamsplitter that is designed to face the incident light. In a filter cube this is the side that faces both the light source and the specimen. Beamsplitters generally perform better when oriented correctly.

**FWHM**

*See* Bandwidth.

**Half-cone angle (p. 9)**

The angle between the most oblique ray of a convergent or divergent light beam and the optical axis of the beam. *See also* Numerical aperture.

**Heat filter (p. 6)**

An optical filter that attenuates infrared radiation but transmits the visible. Attenuation is achieved by means of absorption (using filter glass), reflection (using a thin-film interference coating, often called a hot mirror), or a combination of the two.

**Hot mirror**

*See* Heat filter.

**Indirect fluorescence (p. 2)**

*Also* Secondary fluorescence. In fluorescence microscopy, fluorescence emitted by fluorochromes introduced into a specimen as a stain or probe. *See* Primary fluorescence.

**Infinity-corrected optics (p. 22)**

An optical configuration employed by some microscopes in which the objective forms an image at infinity, and a secondary tube lens forms an image at

the intermediate image plane. (This intermediate image is focused in turn by the ocular.) This configuration allows for a flexible distance between the objective and ocular because the distance between the objective and the tube lens can be varied without affecting the image-forming characteristics of the microscope. Note that objectives designed for infinity-corrected optics are not interchangeable with objectives designed for standard tube-length optics.

---

**Interference filter**

*See* Thin-film interference coating.

**Köhler illumination (pp. 21)**

The type of illumination optics, usually used in wide-field epifluorescence microscopes, in which the image of the light source is completely out of focus at the specimen plane.

**Longpass (LP) (p. 8)**

An optical filter that attenuates shorter wavelengths and transmits longer wavelengths over the active range of the spectrum (which depends on the specific application). LP filters are denoted by the cut-on wavelength at 50% of peak transmission.

**Luminance**

*See* Radiance.

**Nanometer (nm) (p. 2)**

A unit of length commonly used for measuring the wavelength of light: 1 nm = 10 angstroms (Å) =  $10^{-9}$  meters; and 1000 nm = 1 micron ( $\mu$ ) =  $10^{-6}$  meters.

**Near-infrared (NIR) (p. 3)**

The region of the electromagnetic spectrum ranging in wavelength from approximately 750 to 2500 nanometers.

**Neutral-density (ND) filter (p. 6)**

An optical filter that attenuates light by an amount independent of the wavelength within the useful range of the filter. Metal-coated filters typically have a wider neutral range than glass filters and are more heat-tolerant.

**Normal incidence (p. 9)**

An angle of incidence of zero degrees.

**Numerical aperture (NA) (p. 7, 19)**

In the microscope, a measure of the effective cone-angle of light focused onto the specimen (NA of the condenser) or light captured by the objective (NA of the objective). A high value of NA improves both the brightness and the resolution of the image. ( $NA = N \sin(\theta)$ , where N is the refractive index of the medium surrounding the specimen and  $\theta$  is the half-cone angle of the light.)

**Optical density (OD) (p. 8)**

A logarithmic unit of transmission:  $OD = -\log_{10}(T)$ , where T is the transmission ( $0 \leq T \leq 1$ ).

**Parallelism**

*See* Wedge.

---

**Photobleaching (p. 3)**

*Also* Fading. A photochemical reaction that causes the intensity of fluorescence to decrease with time.

**Pinholes (p. 21)**

Small breaks in the coating of an interference filter, usually caused by the presence of dust particles on the substrate during coating.

**Polarization (p. 9)**

Restriction of the orientation and phase of the electromagnetic field vibrations caused by propagating light. These vibrations are transverse to the direction of propagation of the light, and can be oriented at some angle around the axis of propagation. When the orientation and the phase of the vibrations change rapidly and randomly in time, the light is said to be *unpolarized*. When the vibrations are restricted to one particular orientation angle over an extended length of time, the light is said to be *plane-polarized*. Light can be partially as well as totally plane-polarized. When the relative phase of the vibrations varies with angle in a regular periodic fashion over an extended length of time, the light is said to be *elliptically polarized*. *Circular polarization* is a special case in which the amplitude of the vibrations are equal for all angles. When light is elliptically polarized, the orientation of the vibrations rotates around the propagation axis at the frequency of the light.

When light strikes a specular surface at non-normal incidence, the component of the electric field vibrations parallel to the plane of incidence of the surface (*P-plane*) behaves differently than the component perpendicular to the plane of incidence (*S-plane*). This causes a polarizing effect that is aligned orthogonally to the orientation of the surface.

**Polychroic (p. 27)**

A name for a dichroic beamsplitter that has multiple reflection bands and transmission regions.

**P-plane**

*See* Polarization.

**Primary fluorescence (p. 2)**

In fluorescence microscopy, fluorescent emissions from the specimen itself rather than emissions from any fluorochromes present in the specimen. *See also* Autofluorescence.

**Quantum efficiency (p. 3)**

A measure of how efficiently a fluorochrome converts absorbed radiation into emitted fluorescence.

---

**Quenching (p. 4)**

Any chemical process which reduces the quantum efficiency of a fluorochrome *in situ*.

**Radiance (p. 15)**

A measure of the radiometric brightness of a light source. Technically, the radiance is the radiant flux emitted per unit solid angle per unit area of the light source. A common unit is watts per steradian per square centimeter. Luminance is a measure of the brightness of a light source as perceived by the human eye (i.e., a photometric measure), commonly measured in candelas per square centimeter.

**Registration shift (p. 22)**

A shift in the apparent position of the specimen that occurs when an optical element is inserted or removed, adjusted, or switched with another element.

**Scratch/dig (p. 21)**

A set of specifications for defining the maximum allowable size and number of scratches and digs on an optical surface. The scratch/dig values (e.g., 80/50) specify the scratch width in microns and the dig diameter in tens of microns, respectively. Although extensive evaluation procedures exist if rigorous standards must be maintained (military specification MIL-F-48616, for example), a qualitative visual assessment of the scratches and digs usually suffices.

**Secondary fluorescence (p. 6)**

*See* Indirect fluorescence.

**Shortpass (SP) (p. 8)**

An optical filter that attenuates longer wavelengths and transmits shorter wavelengths over the active range of the spectrum (which depends on the specific application). SP filters are denoted by the cut-off wavelength at 50% of peak transmission.

**Signal-to-noise (S/N) (p. 14)**

A measure of the brightness of the desired fluorescence (the signal) relative to the brightness of the background (the noise).

**Slope (p. 9)**

A measure of the sharpness of the transition from the transmitting region to the blocking region of a color filter.

**Spectrofluorimeter, also spectrofluorometer (p. 2)**

An instrument used for measuring the excitation and emission spectra of a fluorescent substance.



---

## **S-plane**

*See* Polarization.

## **Standard tube-length optics (p. 22)**

An optical configuration employed by most microscopes in which the objective forms an image at the intermediate image plane. (This intermediate image is focused in turn by the ocular.) The distance between the nosepiece that holds the objective and the barrel that holds the ocular is fixed at a standard length of 160 mm so that objectives can be interchangeable between microscopes. *See also* Infinity-corrected.

## **Stokes shift (p. 3)**

The shift in wavelength between the peak excitation intensity and peak emission intensity of a fluorochrome.

## **Sub-Pixel Registration (SPR) (p. 24)**

A term used to describe filter sets that are manufactured to a level of precision that eliminates variations in image registration when switching filters or filter-cubes.

## **Substrate (p. 5)**

The ground and polished piece of optical glass that is used as a base for the beamsplitter coating.

## **Surface flatness (p. 20)**

A measure of the deviation of the surface of an optical element from a perfect plane, measured in fractions or multiples of a wavelength of visible light (usually 550 or 630 nm).

## **TE-mode**

Another term for S-plane polarization. (Short for “transverse-electric” mode.) *See* Polarization.

## **Thin-film interference coating (p. 11)**

A type of optical coating composed of a stack of microscopically thin layers of material. Although each material is intrinsically colorless, the reflections created at each interface between the layers combine through wave interference to selectively reflect some wavelengths of light and transmit others. Thin-film interference coatings are the main component of interference filters, which consist of one or more coatings separated by glass substrates and frequently one or more layers of filter glass.

## **TM-mode**

Another term for P-plane polarization. (Short for “transverse-magnetic” mode.) *See* Polarization.

---

**Transmitted wavefront distortion (TWD) (p. 20)**

A measure of the distortion a plane wave of light undergoes when transmitted through an optical element, measured in fractions or multiples of a wavelength of visible light (usually 550 or 630 nm).

**Ultraviolet (UV) (p. 3, fig. 2)**

The region of the electromagnetic spectrum ranging in wavelength from approximately 100 to 400 nanometers. Three distinct bands are: 1) near-UV, from 320 to 400 nm; 2) mid-UV, from 190 to 320 nm; and 3) vacuum-UV (VUV), below 190 nm. The terms UV-A and UV-B denote bands with distinct physiological effects: 320 to 380 nm and 280 to 320 nm, respectively.

**Wedge (p. 20)**

*Also Parallelism.* A measure of the deviation of the outer surfaces of an optical element from perfect parallelism, usually measured in arc-minutes or arcseconds of angle.

**Wide-field (p. 21)**

An epifluorescence microscope in which the full field of view is illuminated, in contrast to a confocal epifluorescence microscope. The term *brightfield* is also used, but this might be confused with traditional diasopic brightfield illumination.





CORPORATE HEADQUARTERS  
AND MANUFACTURING

## CHROMA TECHNOLOGY CORP

10 Imtec Lane  
Bellows Falls, VT 05101-3119 USA  
Toll Free 800 824 7662 (800-8CHROMA)  
Voice +1 802 428 2500  
sales@chroma.com

### INTERNATIONAL SALES AND SUPPORT

---

#### CHROMA GMBH

Voice +49 8142 2847525  
Voice +49 8142 2847526  
europe@chroma.com

#### CHROMA CHINA

Voice +86 0592 5062089  
china@cn.chroma.com

#### CHROMA JAPAN

Voice +81 045 285 1583  
japan@chroma.com



Printed on paper with 10% post-consumer fiber content  
with vegetable-based inks